



ASIC

Australian Securities & Investments Commission

BUSINESS NAMES

MESSAGE IMPLEMENTATION GUIDE FOR ASIC REGISTERED SOFTWARE DEVELOPERS

V2.5

Purpose: This document provides guidance to software developers for the implementation of Business Name register related web services offered by ASIC

Date: 26 February 2016

Contact: For further information or questions, contact ASIC at webservices@asic.gov.au

DOCUMENT CHANGE CONTROL

Version number	Date of issue	Author(s)	Brief description of change
0.1	12/09/2011	ASIC	Initial Draft
1.0	19/09/2011	ASIC	Final candidate release
2.0	09/03/2012	ASIC	Section 2: Remove AUSkey option Section 5: <ul style="list-style-type: none"> - remove Message specification validateKey - update Message specification queryAddress - update Message specification Lodge Application Section 6: removed Section 7: removed
2.1	03/05/2012	ASIC	Update to queryAddress request section Update to bnLodgeApplication request section Add section ‘Business Document Body’ to bnLodgeApplication reply Add Appendix C – List of values
2.2	01/09/2013	ASIC	Updated bnLodge and queryAddress schemas to support Postal address types in the Address for Service (GE) as optional elements in physicalAddress node.
2.3	06/12/2013	ASIC	Updated section 4.3 – add bnRenewal service Add Section 6: <ul style="list-style-type: none"> - Add Message specification bnRenewal
2.4	12/09/2014	ASIC	Update section 3 – Signatory
2.5	26/02/2016	ASIC	ACNC flag added to searchNniName and getNni reply messages. New version 3 created for each message. This change is supported in production from 21/03/2016. Former names of the entity are returned in the getNni reply message. This necessitates a renumbering of some elements in getNni reply. Version 2 searchNniName and getNni messages will cease to be supported on 30/09/2016.

DISCLAIMER

This specification is current at the latest date shown in the Document Change Control, but it may be amended at any time without prior notice. Only those organisations that have been registered by the Australian Securities and Investments Commission (ASIC) will be notified of changes.

ASIC is not responsible for the quality or merchantability of software developed on the basis of this specification, nor is it responsible for any application packages developed by third parties to access ASIC databases through the BN Web Services interface. ASIC does not support such software in any form.

COPYRIGHT

Copyright© Australian Securities and Investments Commission 2013 with all rights reserved

This document is the property of ASIC. No part of this document may be copied or used in other publications unless ASIC authorship is acknowledged

TABLE OF CONTENTS

1.	INTRODUCTION	6
1.1.	Purpose	6
1.2.	Audience	6
1.3.	Context	6
1.4.	Glossary	7
2.	AUTHENTICATION AND AUTHORISATION	7
3.	SIGNATORY	8
4.	ASIC BUSINESS NAME INTERACTION MODEL	11
4.1.	Web Services	11
4.2.	Prerequisites	11
4.3.	Services Offered.....	12
4.4.	Service Summary.....	12
4.5.	Message Specification	12
5.	APPLICATION FOR A BUSINESS NAME.....	13
5.1.	Prerequisites	14
5.2.	Service Summary.....	14
5.3.	Message Specification – queryNameAvailability	17
5.3.1.	Business Overview	17
5.3.2.	HTTPS Connections & WSDL	17
5.3.3.	queryNameAvailability Request Message	18
5.3.4.	queryNameAvailability Reply Message	21
5.4.	Message Specification - searchNniName	23
5.4.1.	Business Overview	23
5.4.2.	HTTPS Connections & Proxy Servers	23
5.4.3.	searchNniName Request Message	23
5.4.4.	searchNniName Reply Message	27
5.5.	Message Specification - getNni	31
5.5.1.	Business Overview	31
5.5.2.	HTTPS Connections & WSDL	31
5.5.3.	getNni Request Message	31
5.5.4.	getNni Reply Message.....	35
5.6.	Message Specification - queryAddress	40
5.6.1.	Business Overview	40
5.6.2.	HTTPS Connections & WSDL	40
5.6.3.	queryAddress Request Message.....	40
5.6.4.	queryAddress Reply Message	44
5.7.	Message Specification - bnLodgeApplication	45
5.7.1.	Business Interaction Overview	45
5.7.2.	HTTPS Connections & WSDL	48
5.7.3.	bnLodgeApplication Request Message	48
5.7.4.	bnLodgeApplication Reply Message	67
6.	MAINTAINING A BUSINESS NAME.....	70
6.1.	Prerequisites	70
6.2.	Service Summary.....	70
6.3.	Message specification - bnrenewal	70
6.3.1.	Business Overview	70

6.3.2.	HTTPS Connections & WSDL	71
6.3.3.	bnRenewal Request Message	71
6.3.4.	bnRenewal Reply Message	75
APPENDIX A – MAPPING ABR ENTITY TYPES TO ASIC ENTITY TYPES.....		76
APPENDIX B - RENEWAL DATE ALIGNMENT		80
APPENDIX C – LIST OF VALUES.....		81

1. INTRODUCTION

1.1. PURPOSE

The purpose of this document is to provide detailed information on how Software Developers can use Web Services offered by ASIC to search and update ASIC's Business Name register. The document is designed to provide an understanding of the Web Service operations and associated XML message requests and replies needed to communicate with these services.

1.2. AUDIENCE

The intended audience for this document are third party software developers that will be developing and implementing systems that will use ASIC Business Name register web services. This includes Project Managers, Software Engineers, Software Testers and other interested groups that are involved in the software development process.

Readers should be familiar with the following:

- For information related to Business Names in general – please see <http://www.asic.gov.au/asic/ASIC.NSF/byHeadline/Business%20names#s> for further information.
- Web Services technical information – please see www.ws-i.org for further information.
- **Web Services Implementation Guide v2.2** – this document is issued in conjunction with the Message Implementation and defines all structural and common elements related to ASIC specific messaging for these services.
- External M2M Error code v2.0

1.3. CONTEXT

The ASIC Business Names web services require software developers to develop W3C compliant SOAP services to interact with ASIC web services interfaces.

ASIC will deliver a suite of documents and technical products to support software developers with the implementation of the web services required for the interactions with the ASIC Business Names register.

The common technical components and services that are re-used by all services are covered in the **Web Services Implementation Guide v2.2** and it is assumed that the reader is familiar with this document.

The **Messages Implementation Guide** (this document) details the Web Service operations available for the secure B2G automated transactions between the Registered Agents and ASIC.

It covers the web service specification for each message/interaction that can be consumed by the software applications including a business overview of the functionality provided. It describes the structure of the request and the response messages detailing the SOAP Body elements and their business meaning, the business rules and validations applied to the payload of request messages. For the full list of error codes and descriptions please refer to the External M2M Error code document.

Note that the web service specification defines what the service is, but not how the service is implemented and therefore is agnostic of the operating system and the software language used.

1.4. GLOSSARY

For definition of the terminology and acronyms used within this document, please refer to the following list:

Term	Description
ABN	The Australian business number (ABN) is a unique 11 digit identifier that makes it easier for businesses and all levels of government to interact. It is not compulsory to have an ABN, but it is an essential component for businesses to operate within the goods and services (GST) system. If you are registered for GST, you will need to put your ABN on your invoices to make them 'tax invoices'. Link to more information on the ABR's website.
Account number	The Business Name account number is an 11 digit number located on any ASIC issued invoice or Renewal Notice reminder letter. The account number is the 9 digit nniNumber with 85 at the start. If the nniNumber has fewer than 9 digits insert leading zeroes to make it 9 digits. For example, the account number for nniNumber 14526933 is 85014526933.
ACNC	Australian Charities and Not-for-Profits Commission
AUSkey	Online security credential that is a single secure sign-on for accessing a range of government online services
B2G	Business to Government machine to machine interaction
HTTPS	Hypertext Transfer Protocol Secure – a web protocol that provides encryption and secure connection.
M2M	Machine-to-Machine - refers to technologies that allow systems to communicate with other devices, in this case it represents that communication between software applications and ASIC system using web services via internet connection
SOAP	SOAP (Simple Object Access Protocol) defines a standard communication protocol for Web Services.
WSDL	Web Services Description Language
XML	XML (eXtensible Markup Language) is a meta-markup language that can be used to define data formats. XML data formats can be interpreted by any application, written in any language, running on any platform. XML data formats can also be transformed on the fly to adapt to the needs of a specific application.
XML Schema	XML Schemas express shared vocabularies and allow machines to carry out rules made by people. They provide a means for defining the structure, content and semantics of XML documents.

2. AUTHENTICATION AND AUTHORISATION

There are two authentication models described in the Web Services Implementation Guide for ASIC Business Name web services.

- a) A username & password credential issued by ASIC or alternatively,
- b) The use of the Whole of Government authentication mechanism AUSkey via STS (Secure Token Service) is also supported.

The details on how the authentication and authorisation need to be implemented are outlined in the Web Services Implementation Guide v2.2 (WIG) and the described implementation is consistent across all services.

The authorisation for the request messages is based on the sender information (i.e. senderType and senderId) that is provided in the SOAP Body – Business Document Header.

3. SIGNATORY

Some of the ASIC Business Names request messages contain a 'Signatory' section that includes a few statements indicating that the information contained is deemed "true and correct".

To make a declaration, the sender needs to be cognisant of two things:

- The statements they are making, and
- That it becomes a form of declaration by them agreeing to it.

As a result, in every case where a 'signatory' is required to accompany a transaction, the sender must have displayed to them:

- Declaration – containing the specific statements describing what they are about to declare.
- Authority – containing the authority under which the declaration is being made

The software developer is to include the ASIC Eligibility Declaration prior to the final 'declaration' being made by a business name applicant. The applicant must declare that the following statements are true to confirm eligibility to register a business name. If either of these statements is untrue and the applicant wishes to proceed the applicant must be referred to ASIC to determine whether they are eligible under the Business Names Registration Act 2011.

The text of the 'Declaration' and 'Authority' section must display the following:

<p><i>Individual applicant</i></p> <p>Authority</p> <p>If you are not the applicant, you must be authorised by the applicant to make each of the declarations on behalf of the applicant and to submit this application.</p> <p>See <u>who may be authorised to lodge an application to register a business name</u> for more information.</p> <ul style="list-style-type: none"><input type="checkbox"/> This application is submitted under, and is compliant with, the terms and conditions of the <u>ASIC Electronic Lodgment Protocol</u>. <input type="checkbox"/> To the best of my knowledge, the information supplied in this application is complete and accurate (it is an offence to provide false or misleading information to ASIC).	<p>Declaration</p> <p>Please select one.</p> <p>I declare that:</p> <ul style="list-style-type: none"><input type="checkbox"/> I am the applicant (the proposed business name holder) <input type="checkbox"/> I am lodging this application on behalf of the applicant (the proposed business name holder) and am authorised to:<ul style="list-style-type: none">• submit this application for lodgment on behalf of the applicant under the terms and conditions of the ASIC Electronic Lodgment Protocol; and • make each of the above declarations on behalf of the applicant after making all due and proper enquiries. <p>ASIC may contact the applicant or the lodging party (if any) if there are any questions regarding this application for registration of a business name</p>
--	--

<p>Eligibility</p>	<p>The applicant must declare that the following statements are true to confirm eligibility to register a business name. If either of these statements are untrue your application will be forwarded to an ASIC staff member to determine whether you are eligible under the Business Names Registration Act 2011</p> <p>If you are not the applicant you must be authorized by the applicant to make either of these declarations on behalf of the applicant:</p> <p>Declaration by applicant of eligibility to hold a business name:</p> <ul style="list-style-type: none"> • I am not disqualified from managing corporations under section 206B(1) of the Corporations Act 2001; and <p><input type="checkbox"/></p> <ul style="list-style-type: none"> • Within the last 5 years I have not been: <ul style="list-style-type: none"> • convicted of, or • released from prison after being convicted of, and serving a term of imprisonment for, any of the criminal offences referred to in section 32(1) (c) or (d) of the Business Names Registration Act 2011
<p><i>Other than individual applicant</i></p> <p>Authority</p> <p>If you are not the applicant, you must be authorised by the applicant to make each of the declarations on behalf of the applicant and to submit this application.</p> <ul style="list-style-type: none"> <input type="checkbox"/> This application is submitted under, and is compliant with, the terms and conditions of the <u>ASIC Electronic Lodgment Protocol</u> <input type="checkbox"/> To the best of my knowledge, the information supplied in this application is complete and accurate (it is an offence to provide false or misleading information to ASIC). 	<p>Declaration</p> <p>I declare that:</p> <ul style="list-style-type: none"> <input type="checkbox"/> I am lodging this application on behalf of the applicant (the proposed business name holder) and am authorised to: <ul style="list-style-type: none"> • submit this application for lodgment on behalf of the applicant under the terms and conditions of the ASIC Electronic Lodgment Protocol; and • make each of the above declarations on behalf of the applicant after making all due and proper enquiries. <p>ASIC may contact the applicant or the lodging party (if any) if there are any questions regarding this application for registration of a business name.</p>

<p>Eligibility</p>	<p>The applicant must declare that the following statements are true to confirm eligibility to register a business name. If either of these statements are untrue your application will be forwarded to an ASIC staff member to determine whether you are eligible under the Business Names Registration Act 2011</p> <p>If you are not the applicant you must be authorized by the applicant to make either of these declarations on behalf of the applicant:</p> <p>Declaration by applicant of eligibility to hold a business name:</p> <ul style="list-style-type: none"> • I am not disqualified from managing corporations under section 206B(1) of the Corporations Act 2001; and <p><input type="checkbox"/></p> <ul style="list-style-type: none"> • Within the last 5 years I have not been: <ul style="list-style-type: none"> • convicted of, or • released from prison after being convicted of, and serving a term of imprisonment for, any of the criminal offences referred to in section 32(1) (c) or (d) of the Business Names Registration Act 2011
---------------------------	---

The sender must sign by actively confirming that they are aware of their obligations by using a "tick box", "radio button" , a "submit button" or any similar method that the software developer chooses to implement within their software product.

4. ASIC BUSINESS NAME INTERACTION MODEL

The ASIC Business Name system uses web services to interact with software packages used by the customers interacting with ASIC, including the Registered Agents. The functions available to the agents may require anywhere from a single web service to a complex sequence of web services that need to be executed in a particular order. Any such pre-requisites are noted in this document.

4.1. WEB SERVICES

Web Services provide a platform independent messaging interface that follows the "SOAP with attachments" specification. The information exchange is based on standard Web Services data exchange patterns. ASIC will process request queries or the lodgments requests one at a time; a separate request must be made for each lodgment.

The services covered in this document must be implemented according with the common rules and specifications documented in the **Web Services Implementation Guide v2.2**

4.2. PREREQUISITES

- The customer must register with ASIC for use of M2M Web Services and agree to the terms and conditions of the Electronic Lodgement Protocol

- The customer must obtain a Username & password from ASIC – if this is the authentication model chosen to be implemented by the software developer, or alternatively
- The customer must register their ABN with ASIC in order for the AUSkey authentication (STS Service) to be used.

4.3. SERVICES OFFERED

ASIC Business Names register exposes the following Web Services:

SERVICE	DESCRIPTION
queryNameAvailability	This web service allows Registered Agents to query the availability of a proposed name as a company name or as a business name.
searchNniName	This web service allows searching the ASIC Registers (previously known as National Name Index) by the entity name and optionally the entity type and/or status.
getNni	This service may be used when the application is done on behalf of a company. It can be used to perform data validations and prefill company free public data on the user interface.
queryAddress	This service caters for the validation of Australian addresses against ASIC's Postal Address File.
bnlodgeApplication (bz1)	This web service allows lodgment of applications for registration of a Business name with ASIC.
bnRenewal	This web service enables customer to request an invoice for a Business Name that is due for renewal..

4.4. SERVICE SUMMARY

The service summary table defines the sequence, optionality and repeatability of the service execution. The services that must be executed by the business in order to achieve the outcome of the transaction are identified as 'mandatory'. Repeatability indicates if the service can be executed more than once – 'Yes' meaning that the service can be executed multiple times within the sequence. 'No' does not preclude the user to execute the service again if the execution had failed for technical reasons



4.5. MESSAGE SPECIFICATION

The message specification for each of the services used in an interaction details the business rules and the schema validations pertinent to each service. This is supplemented by the information contained in the WSDL files.

The message specification section of this document also includes a diagrammatic representation of each schema or complex type. The message content tables for both the request and reply messages are also documented.

General characteristics for schema representations:

- **Optional elements** - indicated by a broken line
- **Mandatory elements** - indicated by a continuous line and must be provided or otherwise the request will fail schema validation (returns a SOAP Fault)
- **Mandatory/Optional** - are enforced in a hierarchical structure from root to leaf node. Thus for example if an optional complex element is transmitted, then any mandatory elements within the element must be transmitted.

- **complexType elements** - to simplify the message layout documentation. They consist of set of elements, which have an inherent structure and are combined to form a complex type. An example is an address.
- **Repetition** - elements may be specified to occur multiple times i.e. to repeat. A repeat count in the schema shows the maximum number of occurrences of repeating segments or groups.
- **Mandatory/Conditional/Unused** - elements may be designated to be mandatory or conditional in the definition of a message. Elements may also be designated as being unused when the data they represent is not needed in the particular message type being defined
-  - this indicates that one selection must be made from the available choices
-  - this indicates a sequence of elements that must be provided in accordance with their optionality and the business rules

The Message Content Table Explained:

Each message specification (request and reply) contains a table structure that is used to define the business definition, the structure and business rules of the elements contained within the XML schema. The message content is defined in the table using the following columns:

Sequence Number: This is a sequential number used to indicate the expected order of the data elements within the XML instance document. Elements within a complex content are allocated a multilevel number to indicate the expected structure and order of the elements contained within the group. If there are nested groups then the sequence number goes to next numbering level.

XML Element: This is the name of the data element to be reported.

Type: This is the type of the element and can be a standard XML type or an ASIC defined type.

Description: This is the description of the data element using business terms.

Business Rules/Instructions: This column describes all the rules applicable to the data element. Rules would include information such as optionality, explicit conditions or the expected values and their meaning.

5. APPLICATION FOR A BUSINESS NAME

One of the key services provided is the service for the application for a Business name. This service relies on a number of machine to machine interactions before completing.

Upon lodging the application successfully:

- the Business name will be recorded in ASIC Business Names register pending payment of the registration fee
- an invoice will be provided to the business name holder via email

The business name holder or the authorised lodger must pay the registration fee before the business name becomes fully registered. At this point ASIC will send via email or mail the following documents:

- ✓ Record of Registration
- ✓ ASIC Key
- ✓ Payment Confirmation

5.1. PREREQUISITES

In addition to the conditions listed in section 4.2 Prerequisites:

- The holder of the proposed business name must have a current ABN or have applied for an ABN and is able to quote a valid ABN Reference Number – this is a legislative requirement with minor exceptions related to Christmas and Cocos Island businesses.
- Please note that ABN details will be validated with the ABR in real-time to ensure the ABN/ABN Reference is valid, current and that the corresponding ABN structure has been provided within the context of the Business name application.

5.2. SERVICE SUMMARY

The interactions required for the completion of a Business name registration consist of the following services:

	Service Name	Mandatory	Repeatable
1.	queryNameAvailability This service must be used for checking the availability of the proposed business name against existing records in ASIC registers. The use of this service will provide end-users with an early indication of the availability of the proposed name.	Yes	Yes
2.	searchNniName This service may be used for checking the names similar with the proposed business name that are already registered in ASIC registers.	No	Yes
3.	getNni This service may be used when the application is done on behalf of a company. It can be used to perform data validations and prefill company data on the user interface.	No	Yes
4.	queryAddress This granular service may be used for the validation of addresses contained in the application for registration of a business name against the ASIC's Postal Address File. This service, if used, will result in potentially fewer issues with the final application itself.	No	Yes
5.	lodgeApplication(bz1) This service must be used to lodge the application for registration of a new Business name with ASIC and must comply with all the required data specifications.	Yes	No

Details of each service are provided within the next sections of this document.

In a typical scenario of an application for registration of a Business name the user must perform the following steps:

1. Start the application to register a business name and provide a proposed business name and check if name the name is available - use of the queryNameAvailability service

2. Check similar names to ensure that there is no perceived conflict with an existing organisation name - use searchNni service
3. Provide details of the Business name holder (holding entity/business structure – as per ABN), the addresses of the business and the term of registration for the business name (1 or 3 years).
4. Optionally each address may be validated against Postal Address File (use queryAddress service). Address types include:
 - a. Address for service of documents (Australian physical address only)
 - b. Principal place of business (Australian physical address only)
 - c. Residential addresses for individuals (it can be Australian or Foreign addresses)
5. Agree to the terms of the 'Declaration'
6. Submit the application (using: ***bnLodgeApplication***)

This process flow can be diagrammatically represented as follows:

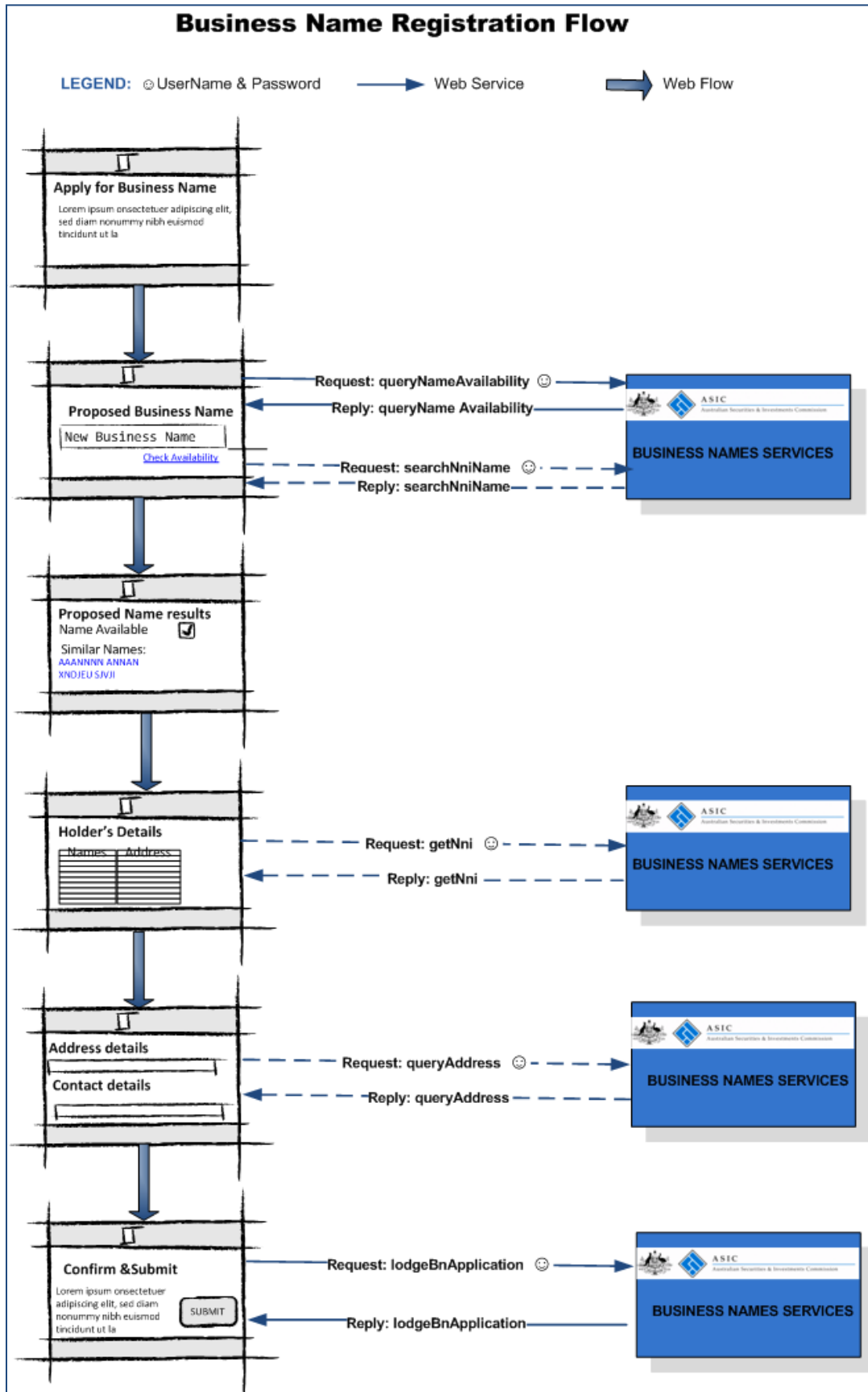

5.3. MESSAGE SPECIFICATION – queryNameAvailability

5.3.1. Business Overview

This web service allows users to query and check ASIC's registers (i.e. companies or business names) for the availability of a proposed name, including the availability of a cancelled business names that is intended for transfer (of registration).

The proposed name is tested against the following criteria¹:

- Check for identical and near identical names
- Check for invalid symbols
- Check for restricted words including known words such as “ASX”, “BANK”, etc
- Check for unknown words

In addition to the criteria listed above, additional criteria will be introduced for the purposes of determining whether a Business Name is available when ASIC commences the administration of national Business Names Register. These criteria are documented in the legislation and include at a conceptual level:

- Word group order
- Phonetic (sounds-like) similarity

Below is the high level definition of the queryNameAvailability service.

Request includes:

- the proposed name
- existing holder details which allows similar results to be ignored if the names are already owned by that entity

Reply includes:

- The result provides information regarding the availability of the name based on the result of the names determination function. For example: name is available or name not available or name must be referred to manual determination (i.e. a manual process of assessing the particular instance) or that a name has been previously cancelled and it is available to be transferred to a new holder
- Objections that provide additional information regarding the reason(s) why an application for this name would result in rejection or referral.

5.3.2. HTTPS Connections & WSDL

The requestor's code must establish a HTTPS connection to the appropriate endpoint using the standard port 443.

Environment	WSDL
--------------------	-------------

¹ These are the existing names determination validations / checks that are performed for Company name availability.

Production	https://www.gateway.asic.gov.au/gateway/ExternalQueryNameAvailabilityPortV2?WSDL
Test	https://www.gateway.uat.asic.gov.au/gateway/ExternalQueryNameAvailabilityPortV2?WSDL

5.3.3. queryNameAvailability Request Message

Business Document Header

The WIG provides the specification of the Business Document Header. The following table specifies the message specific data element values or any variations to the WIG.

Element Name	Instructions / Rules	Error code
MessageType	Mandatory, value must be "queryNameAvailability"	00002
MessageVersion	Mandatory, value must be 2	00004
senderType	Mandatory, value must be "REGA"	00005
senderId	The identifier assigned by ASIC on registration	00005

Business Document Body

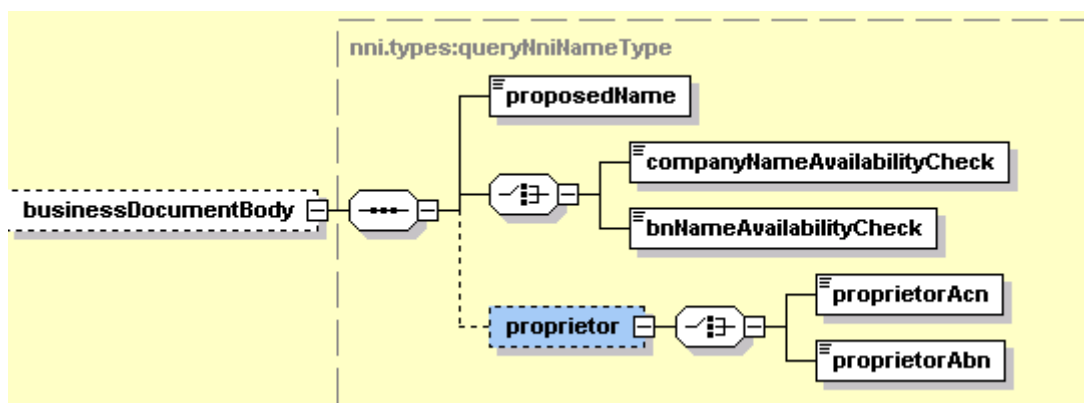

Message Content Table

Seq.No	XML Element	Type	Description	Business Rules/Instructions
1	proposedName	types:nniNameType	The proposed entity name.	<ol style="list-style-type: none"> 1. Must use UPPERCASE and it can contain spaces. 2. Valid characters are: <ul style="list-style-type: none"> ✓ letters, that is alphabetic characters A to Z ✓ numbers, that is numeric characters 1 to 9 and 0 ✓ standard use punctuation marks such as . , ? ! () { } : ; ‘ “ ” ✓ the symbols -) _ \ / which are treated as punctuation ✓ the symbols @ # \$ % * = and the ampersand ‘&’
2	companyNameAvailabilityCheck	types:trueType	Indicator to perform names determination query against Company rules	<ol style="list-style-type: none"> 1. Setting a value of “true” performs a check to determine the availability of the name as a company name
3	bnNameAvailabilityCheck	types:trueType	Indicator to perform names determination query against Business names rules	<ol style="list-style-type: none"> 1. Setting a value of “true” performs a check to determine the availability of the name for a business names <p>Note that for the purpose of lodging the application for business names, this value must be ‘true’.</p>
4	proprietor	Complex content	Contains one identifier (i.e. ACN or ABN) for an entity that intends to apply for a new business name. When one identifier is provided than the same holder exemption is applied so the holder can have a name that is similar or nearly identical with the company/entity name	
4.1	proprietorAcn	types:nniNumberType	ACN for the company that intends to apply for a new business name and whose name may be similar or nearly identical to the proposedName	<ol style="list-style-type: none"> 1. The ACN provided must exist in ASIC register 2. The ACN provided must belong to a registered company 3. Specific to Business Name Availability query

Seq.No	XML Element	Type	Description	Business Rules/Instructions
				only
4.2	proprietorAbn	types:abnType	ABN for the holder of new business names whose other names may be similar or nearly identical to the proposedName.	<ol style="list-style-type: none"> 1. The ABN provided must exist in ABR register 2. The ABN provided must belong to a registered business 3. Specific to Business Name Availability query only

5.3.4. queryNameAvailability Reply Message

Business Document Body

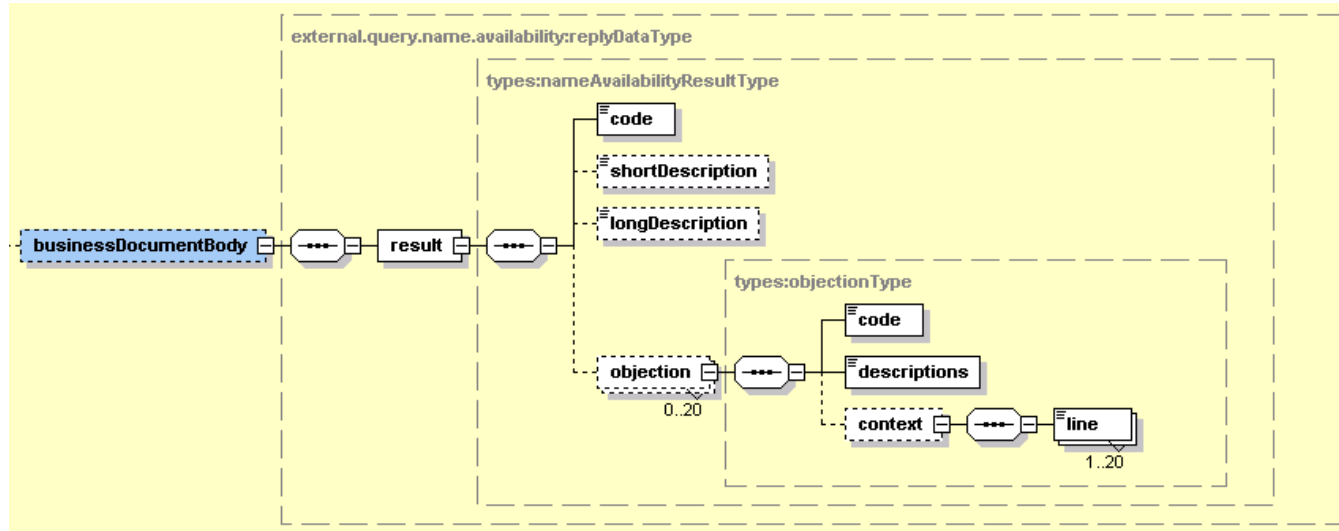

Message Content Table

Seq No	XML Element	Type	Description
1	result	complexType	Contains the result of the name determination
1.1	code	xs:string	Will return one of the following valid values : Available – the name is available to be used as a business name (or company name) – depending on which Name Availability check was requested Unavailable – the name can't be used and the user should propose another name SubjectToNamesDetermination – the name is referred to ASIC staff for manual assesment UnderTransfer – the name has been previously cancelled with the intention to transfer to another business name holder (status valid for business names only)

Seq No	XML Element	Type	Description
			Identical and near identical– meaning the name is conflicting with another name(under the applicable legislation) and it will be rejected
1.2	shortDescription	xs:string	A short text description associated with the result code returned that should be displayed to the users in order to help them understand the result of the query (if the name availability outcome is being presented in a UI).
1.3	longDescription	xs:string	Long text description associated with the result code returned that should be displayed to the users in order to help them understand the result of the query (if the name availability outcome is being presented in a UI).
1.4	objections	complexType	Indicates the reason for a rejection or for a referral to manual determination using an ASIC code and a user description. Note that: 1. No objections are returned in the case where result code is 'Available' 2. No objections are returned if a Company Name availability check is requested
1.4.1	code	xs:string	Examples (code - description) of some common objections: ABORCORP - objectionable without consent of minister BUSSNAME - name is identical to a registered business name CONFEDRL - name suggests connection with federal government EXISTCOY - identical to an already registered corporation INVCHARS - name contains invalid characters OFFENSIV - offensive to public or group of public UNACCEPT - name is considered unacceptable Please note that is best to develop a generic process to display the code and description as opposed to hard coding these. ASIC may in time choose to tweak or embellish upon the objection descriptions.
1.4.2	descriptions	xs:string	
1.4.3	context	complexType	Additional information returned when the name is identical or near identical to another existing name.
1.4.3.1	line	xs:string	Contains the ASIC internal identifier and the business name or Australian Company Number and the company name that resulted in the exact match (i.e. the existing registered name).

5.4. MESSAGE SPECIFICATION - searchNniName

5.4.1. Business Overview

This web service may be used for searching ASIC registers for registered businesses or companies with names similar with the proposed business name. It allows the searching of the National Name Index using the entity name as search criteria and optionally the type or status of the entity. The request must specify if the search should look for an exact match or for all matching entries.

Request includes:

- entity name and optionally its status and/or type
- type and scope of the search
- a maximum number of results

Reply includes:

- list of all entities (maximum of 99) that match the specified criteria and their details such as identifier, name, type, status, dates for registration / deregistration / renewal / review
- flag to indicate whether the entity is registered with the Australian Charities and Not-for-Profits Commission (ACNC). It is not mandatory for this information to be displayed in the result that is presented to the user.

If there is no match then the response will indicate this with an error message. If more than 100 entries are found at the exact match level or if no exact match entries are found and more than 100 entries are found at the primary key match levels then the reply will contain an error message which will indicate this.

5.4.2. HTTPS Connections & Proxy Servers

The requestor's code must establish a HTTPS connection to the appropriate endpoint using the standard port 443.

Environment	WSDL
Production	https://www.gateway ASIC.gov.au/gateway/ExternalSearchNniNamePortV3?WSDL
Test	https://www.gateway.uat ASIC.gov.au/gateway/ExternalSearchNniNamePortV3?WSDL

5.4.3. searchNniName Request Message

Business Document Header

The WIG provides the specification of the Business Document Header. The following table specifies the message specific data element values or any variations to the WIG.

Element Name	Instructions / Rules	Error code
MessageType	Mandatory, value must be "searchNniName"	00002

Element Name	Instructions / Rules	Error code
MessageVersion	Mandatory, value must be 3	00004
senderType	Mandatory, value must be "REGA"	00005
senderId	The identifier assigned by ASIC on registration	00005

Business Document Body

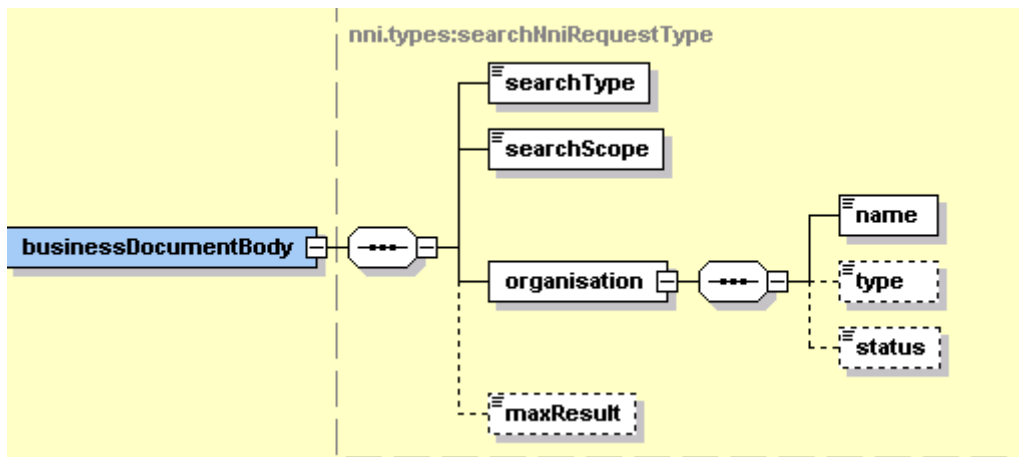

Message Content Table

Sequence No	XML Element	Type	Description	Business Rules/Instructions
1	searchType	xs:string	The type of search to be performed	<p>The valid choices are:</p> <ul style="list-style-type: none"> E – for an Exact (100%) match only S – for the Standard search where all matching entries will be returned <p>Note: In the context of applying for a business name, we suggest to use searchType = S</p>
2	searchScope	xs:string	The scope of the search	<p>Valid scope code:</p> <ul style="list-style-type: none"> 1 – to search for names valid for purchase of extract 2 – to search for names (including former names) of currently registered organisations and reserved names considered for names determination 3 – same as for 2 but including deregistered organisations A – to search for all entities B – to search for Business Names (BUSN) and State Registered Businesses (i.e. ASSN, COOP, LTDP) C – to search for Registered & Deregistered companies, Trusts and NRET's E – to search for Registered companies and NRET's G – to search for Registered companies, Name Reservations, Trusts, NRET's, Business Names and State Registered Businesses (i.e. ASSN, COOP, LTDP) H – to search for Registered & Deregistered companies, Name Reservations, Trusts, NRET's, Business Names (BUSN) and State Registered Names (i.e. ASSN, COOP, LTDP) I – to search for NONC's, Registered companies, Trusts and NRET's J - to search for Registered companies and Name Reservations L – to search for NONC's and Business Names (BUSN) M – to search for NONC's and Name Reservations N – to search for NONC's (Non Company Names) O – to search for NONC's and Registered companies T – to search for Trusts & Registered Schemes R – to search for Registered companies S – to search for Registered companies, Name Reservations, NRET's, Business Names (BUSN) and State Registered Businesses (i.e. ASSN, COOP, LTDP) P – to search for Current Name Reservations X – to search for Registered companies, Name Reservations and Business Names (BUSN)

Sequence No	XML Element	Type	Description	Business Rules/Instructions
				Note: In the context of applying for a business name, we suggest to use searchScope = A
3	organisation	complexType	Contains the name and optionally the type and status for the entity to be searched for	<ol style="list-style-type: none"> 1. The entity with the name & type & status specified must exist in NNI 2. If there are more than 100 names matching then more information must be provided
3.1	name	types:nniNameType	Name of the entity to be searched for in the National Name Index	The name must exist in ASIC records
3.2	type	nni.types:nniTypeCodeType	The type of entity that may be used to narrow down the search results.	Valid values are: APTY - Australian Proprietary Company APUB - Australian Public Company ASSN - Association BUSN - Business Name CHAR - Charity COMP - Community Purpose COOP - Co-Operative Society FNOS - Foreign Company (Overseas) LTDP - Limited Partnership MISM - Managed Investment Scheme NONC - Non Company NRET - Non Registered Entity (Nret) RACN - Registered Australian Body REBD - Religious Body RSVN - Name Reservation SOLS - Solicitor Corporation TRST – Trust If no value is specified, the message will return all types
3.3	status	nni.types:searchStatusType	The status of the entity that may be used to narrow down the search results.	Valid values for business names are: REGD meaning registered business names DRGD meaning cancelled business names PEND – meaning pending business names If no value is specified, the message will return all statuses
4	maxResult	xs:positiveInteger	Maximum number of entities to be returned	The number must be less than 100

5.4.4. searchNniName Reply Message Business Document Body

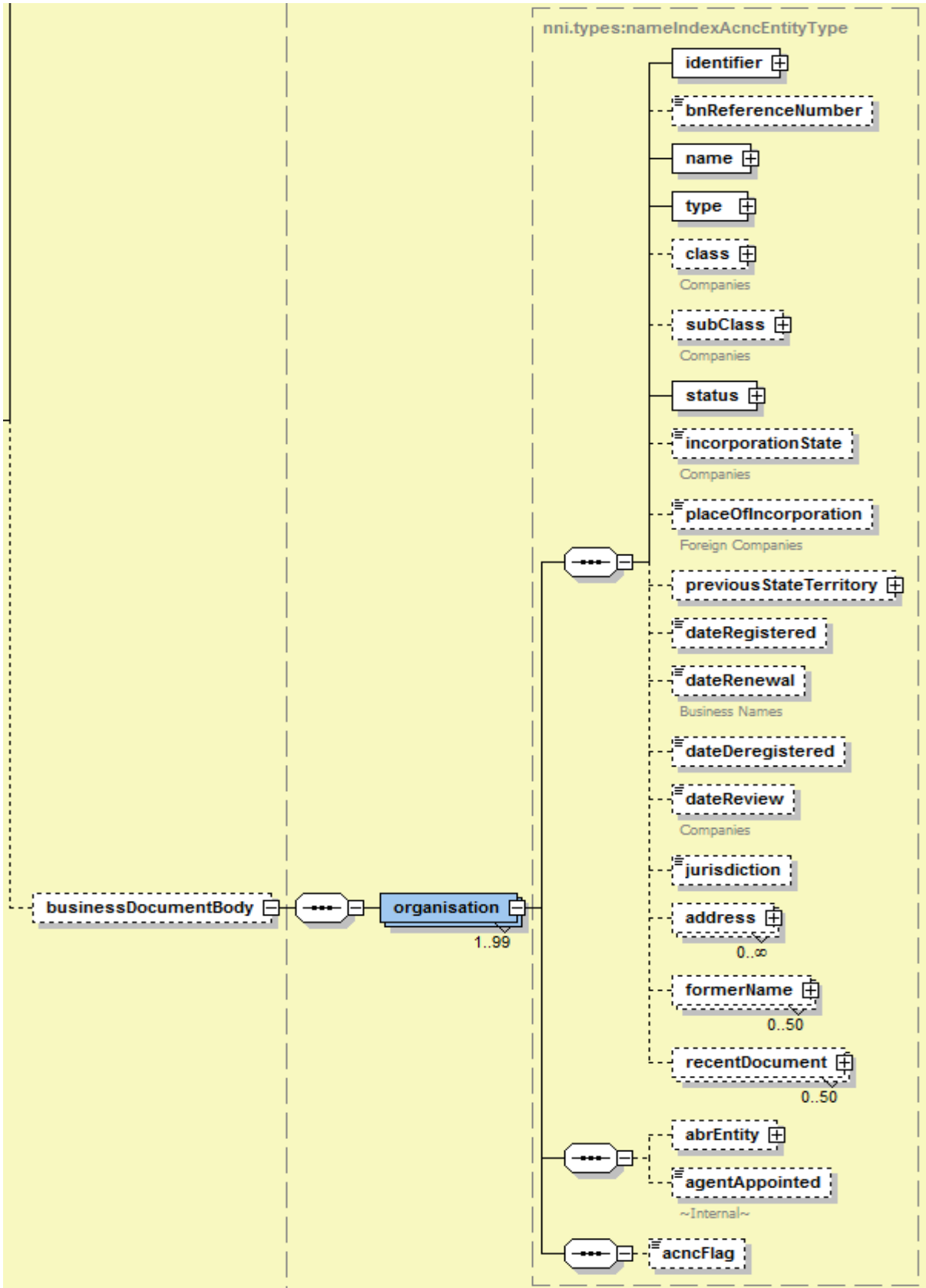

Message Content Table

Seq. No	XML Element	Type	Description
1	organisation	Complex Content	List of organisations that match the criteria specified in the request
1.1	identifier	Complex content	Contains the type and the value for one of the ASIC identifiers such as ACN or ARBN or ARSN
1.1.1	numberHeading	nni.types:numberHeadingType	Type of identifier such as: ACN – meaning Australian Company Number ARBN - meaning Australian Registered Body Number ARSN - meaning Australian Registered Scheme Number Number – used for all other types of identifiers not mentioned above NOTES: <ul style="list-style-type: none"> • ACN, ARBN and ARSN are public identifiers and should be displayed on the user interface; • ‘Number’ indicates that the identifier is not public and must not be displayed on UI (to be used for m2m interactions only)
1.1.2	number	types:nniNumberType	The value of the ASIC unique identifier
1.2	bnReferenceNumber	types:bnReferenceNumberType	Not relevant for this message
1.3	name	types:distinguishedNameType	Contains the organisation name in ASIC registry
1.3.1	name	types:nniNameType	Name of the entity
1.3.2	distinguishedWord	types:distinguishedWordType	The distinguished word that might be used for distinguishing identical business names registered by States & Territories Agencies.
1.4	type	Complex content	Contains the code and a description for the type of organisation
1.4.1	code	nni.type:nniTypeCodeType	Four letter code associated with the type of entity, with the following available combinations of code -description: APTY - Australian Proprietary Company APUB - Australian Public Company ASSN - Association BUSN - Business Name CHAR - Charity COMP - Community Purpose COOP - Co-Operative Society FNOS - Foreign Company (Overseas) LTDP - Limited Partnership MISM - Managed Investment Scheme NONC - Non Company NRET - Non Registered Entity (Nret) RACN - Registered Australian Body REBD - Religious Body RSVN - Name Reservation SOLS - Solicitor Corporation TRST - Trust
1.4.2	description	xs:string	The description of the type of organisations as above. <ul style="list-style-type: none"> ▪ Australian Proprietary Company ▪ Australian Public Company ▪ Association ▪ Business Name ▪ Charity ▪ Community Purpose ▪ Co-Operative Society ▪ Foreign Company (Overseas)

Seq. No	XML Element	Type	Description
			<ul style="list-style-type: none"> ▪ Limited Partnership ▪ Managed Investment Scheme ▪ Non Company ▪ Non Registered Entity (Nret) ▪ Registered Australian Body ▪ Religious Body ▪ Name Reservation ▪ Solicitor Corporation ▪ Trust
1.5	class	Complex content	Contains the class code and the associated description and it applies to entities that are registered by ASIC
1.5.1	code	nni.type:nniTypeCodeType	Code – description list of values: LMGT – Limited by guarantee LMSH – Limited by shares LMSG – Limited by shares and guarantees NLIA – No liability UNLM - Unlimited NONE – Does not have an equivalent Australian liability UNKN – Unknown
1.5.5	description	xs:string	As above
1.6	subclass	Complex content	Contains the subclass code and the associated description and it applies to entities that are registered by ASIC
1.6.1	code	nni.type:nniTypeCodeType	Code - description HUNT - Proprietary – home unit company PNPC - Proprietary – non-profit company PSTC - Proprietary – superannuation trustee company PROP - Proprietary – other LISN - Company licensed under Section 383 to omit 'Limited' from its name LISS - Company licensed under Section 383 to omit 'Limited' from its name– superannuation trustee company LIST - Listed public company NLTD - Non-profit public company registered without 'Limited' in its name under Section 150 ULSN - Unlisted public – non-profit company ULSS - Unlisted public – superannuation trustee company ULST - Unlisted public company
1.6.2	description	xs:string	As above.
1.7	status	Complex content	Contains fields related with the status of the entity
1.7.1	code	xs:string	Various codes including: DMNT Dormant DRGD Deregistered EXAD ** Under External Administration And/Or Controller Appointed ** NOAC Not Active NRGD Not Registered REGD Registered SOFF Strike-Off Action In Progress
1.7.2	description	xs:string	The description of the status associated with the code
1.7.3	isRegistered	xs:boolean	Indicates if the entity is registered with ASIC: 'true' – means that the organisation is currently registered 'false' – means that organisation is not currently registered
1.8	previousStateTerritory	Complex content	To be provided only when the entity is/was registered with State & Territories Agencies.
1.8.1	number	xs:string	The number assigned by the state for registration of the business name
1.8.2	stateTerritoryCode	bn.types;stateTerritoryCode	The name of the state or territory where the business name was registered

Seq. No	XML Element	Type	Description
		Type	
1.9	dateRegistered	xs:date	Not relevant for this message
1.10	dateRenewal	xs:date	Not relevant for this message
1.11	dateDeregistered	xs:date	Not relevant for this message
1.12	dateReview	xs:date	Not relevant for this message
1.13	jurisdiction	xs:string	Not relevant for this message
1.14	address	Complex content	Not relevant for this message
1.15	recentDocuments	Complex content	Not relevant for this message
1.16	abrEntity	Complex content	Not relevant for this message
1.17	acncFlag	xs:boolean	<p>If true, indicates that the entity is registered with the ACNC. It is not mandatory for this information to be displayed when presenting the result of the search.</p> <p>If you choose to include this information, the following text must be displayed with the result of the search:</p> <p>Registered Charity</p> <p>This company is registered as a charity with the Australian Charities and Not-for-Profits Commission (ACNC). For information on the charity, including the address for service, details of responsible persons (for example company directors) and financial reports, search the Charities register at www.acnc.gov.au.</p>

5.5. MESSAGE SPECIFICATION - getNni

5.5.1. Business Overview

This web service may be used for validating or pre-filling data related to entities that are already registered with ASIC (e.g. companies, registered bodies). It allows users to retrieve details of an entity specified in the request by one of the identifiers: ABN, ACN, State Code & State Number or the ASIC internal identifier for a business name.

Request includes:

- One identifier for the entity such as a ACN/ARBN, ASIC internal identifier for business names or a combination of a State & State Number
- Start and end dates and maximum number of documents - to be used as search criteria for returning list of documents lodged with ASIC

Reply includes:

- name of the entity
- type and status of the entity
- dates of registration, deregistration, renewal or review (whichever is applicable based on the entity type)
- registered address of the entity when this information is public
- list of recent public documents (If the request does not specify the start/end dates or the maximum number of documents then the reply returns all documents up to a maximum of 50. If a maximum number of zero is specified no document list is provided)
- former names of the entity, if any
- a flag to indicate whether the entity is registered with the Australian Charities and Not-for-Profits Commission (ACNC). It is not mandatory for this information to be displayed in the result that is presented to the user.

Note that documents lodged against business name register are not publicly available and therefore are not returned by this message.

5.5.2. HTTPS Connections & WSDL

Environment	WSDL
Production	https://www.gateway.asic.gov.au/gateway/ExternalGetNniNamePortV3?WSDL
Test	https://www.gateway.uat.asic.gov.au/gateway/ExternalGetNniNamePortV3?WSDL

5.5.3. getNni Request Message

Business Document Header

The WIG provides the specification of the Business Document Header. The following table specifies the message specific data element values or any variations to the WIG.

Element Name	Instructions / Rules	Error code
MessageType	1. Mandatory , value must be "getNni"	00002
MessageVersion	Mandatory , value must be 3	00004

Element Name	Instructions / Rules	Error code
senderType	Mandatory, value must be "REGA"	00005
senderId	The identifier assigned by ASIC on registration	00005

Business Document Body

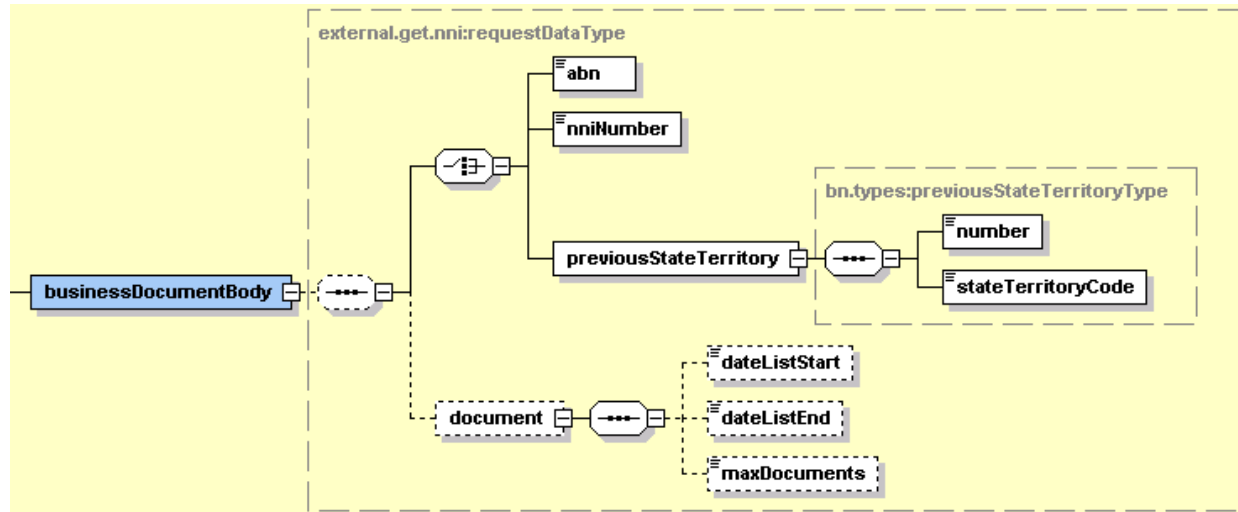

Message Content Table

Sequence No	XML Element	Type	Description	Business Rules/Instructions
1	abn	abnType	ABN as 99999999999	The ABN must exist in ASIC register
2	nniNumber	nniNumberType	ACN or ARBN or ARSN or BNRN	The identifier must exist in ASIC register
3	previousStateTerritory	N/A	Container for previous registration details for business names (before referral of powers to ASIC) or current registration details for entities registered by States and Territories (e.g. associations; co-operatives)	N/A
3.1	number	xs:string	The number assigned by the state for registration of the business.	Must be in a valid format as per schema (i.e. max 10 chars and contains only A-Z , 0-9 and embedded spaces)

3.2	stateTerritoryCode	stateTerritoryCodeType	The name of the state or territory where the business name was previously registered	Valid values as per enumeration: ACT; NSW; NT; QLD; SA; TAS; VIC; WA
4	document	Complex content	Contains the search criteria for the documents to be retrieved and returned Note: The documents related to Business Names are not public information and will not be returned in this message	
4.1	dateListStart	xs:date	To search for documents that have been lodged after this date	The start date for the document list must be before the end date
4.2	dateListEnd	xs:date	To search for documents that have been lodged before this date	The start date for the document list must be before the end date
4.3	maxDocuments	xs:positiveInteger	The maximum number of public documents to be returned; this option is applicable to companies only (documents related to business names are not available to public)	A maximum of 50 recent public documents lodged can be requested to be listed

5.5.4. getNni Reply Message Business Document Body

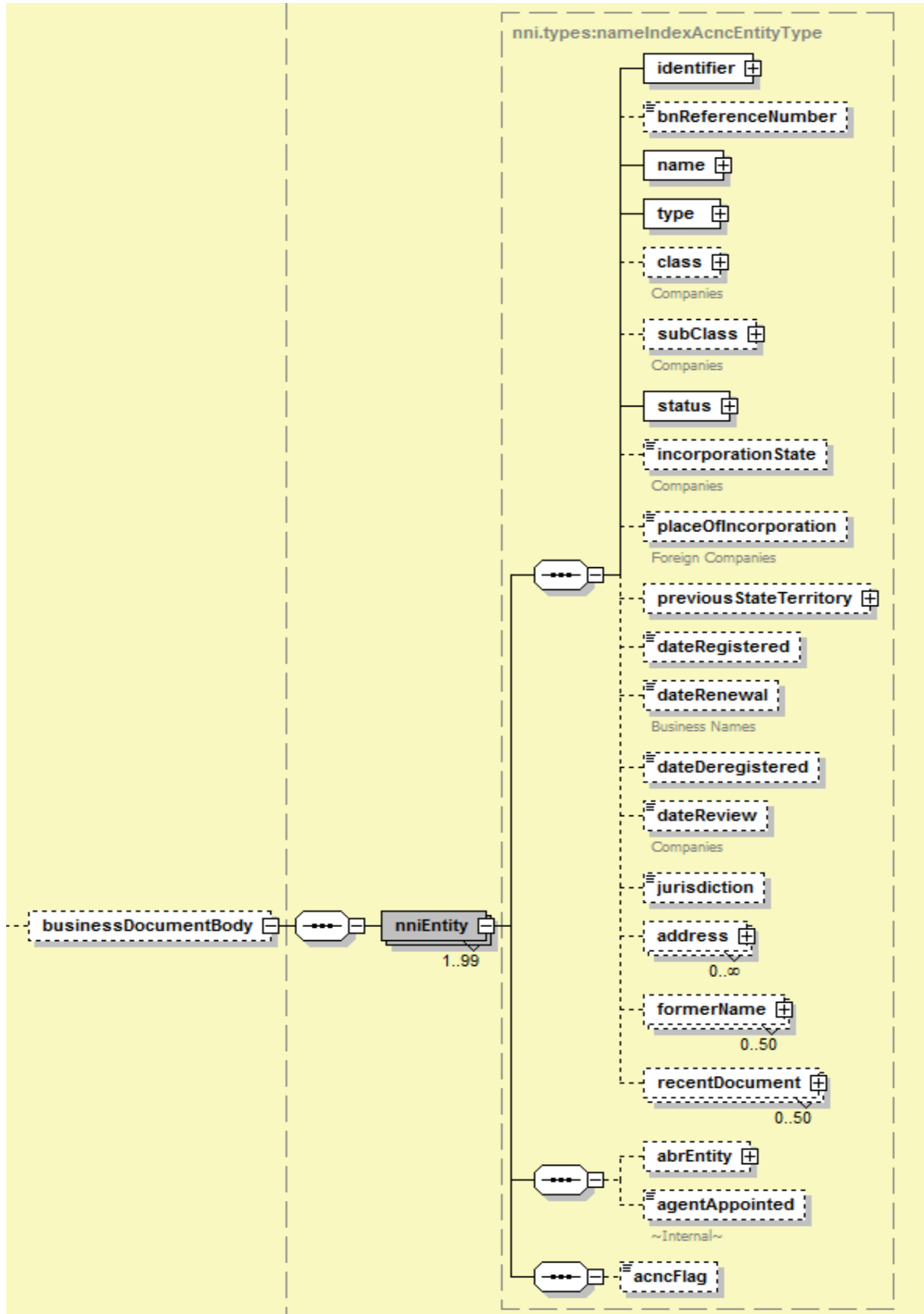

Message Content Table

Seq. No	XML Element	Type	Description
1	nniEntity	Complex content	Contains the data relevant for the entity nominated in the request
1.1	identifier	Complex content	One of the ASIC identifiers such as ACN or ARBN or ARSN
1.1.1	numberHeading	types:numberHeadingType	Type of identifier such as: ACN – meaning Australian Company Number ARBN - meaning Australian Registered Body Number ARSN - meaning Australian Registered Scheme Number Number – used for all other types of identifiers not mentioned above
1.1.2	number	types:nniNumberType	The value of the unique internal identifier relevant to the entity (9 digits)
1.2	bnReferenceNumber	types:bnReferenceNumberType	Not relevant to this message
1.3	name	orgNameType	Organisation name in ASIC registry
1.3.1	name	types:nniNameType	Entity Name
1.3.2	distinguishedWord	types:distinguishedWordType	Distinguished word – used for business names only (i.e. type =BUSN)
1.4	type	get.nni:nniType	Contains the code and a description for the type of organisation
1.4.1	code	xs:string	Contains a four letter code associated with the type of entity, with the following code -descriptions: APTY - Australian Proprietary Company APUB - Australian Public Company ASSN - Association BUSN - Business Name CHAR - Charity COMP - Community Purpose COOP - Co-Operative Society FNOS - Foreign Company (Overseas) LTDP - Limited Partnership MISM - Managed Investment Scheme NONC - Non Company NRET - Non Registered Entity (Nret) RACN - Registered Australian Body REBD - Religious Body RSVN - Name Reservation SOLS - Solicitor Corporation TRST - Trust
1.4.2	description	xs:string	Contains the description of the type of entity as above
1.5	class	Complex content	Contains the class code and the associated description and it applies to entities that are registered by ASIC
1.5.1	code	nni.type:nniTypeCodeType	Code – description list of values: LMGT – Limited by guarantee LMSH – Limited by shares LMSG – Limited by shares and guarantees NLIA – No liability UNLM - Unlimited NONE – Does not have an equivalent Australian liability UNKN – Unknown

Seq. No	XML Element	Type	Description
1.5.2	description	xs:string	As above
1.6	subclass	Complex content	Contains the subclass code and the associated description and it applies to entities that are registered by ASIC
1.6.1	code	nni.type:nniType CodeType	Code - description HUNT - Proprietary – home unit company PNPC - Proprietary – non-profit company PSTC - Proprietary – superannuation trustee company PROP - Proprietary – other LISN - Company licensed under Section 383 to omit 'Limited' from its name LISS - Company licensed under Section 383 to omit 'Limited' from its name– superannuation trustee company LIST - Listed public company NLTD - Non-profit public company registered without 'Limited' in its name under Section 150 ULSN - Unlisted public – non-profit company ULSS - Unlisted public – superannuation trustee company ULST - Unlisted public company
1.6.2	description	xs:string	As above.
1.7	status	statusType	Current status for the entity
1.7.1	code	xs:string	Various codes including: DMNT Dormant DRGD Deregistered EXAD ** Under External Administration And/OR Controller Appointed ** NOAC Not Active NRGD Not Registered REGD Registered SOFF Strike-Off Action In Progress
1.7.2	description	xs:string	The description of the status as above.
1.7.3	isRegistered	xs:boolean	Indicates if the entity is registered with ASIC and it is an interpretation of the values of status code as follows: true – if the organisation is currently registered; false – if the organisation is not currently registered
1.8	incorporationState	types:stateTerritoryCodeType	State of incorporation – provided if the entity is currently incorporated with a State or Territory agency.
1.9	placeOfIncorporation	xs:string	Place of incorporation.
1.10	previousStateTerritory	previousStateTerritoryType	To be provided if the business was previously registered with an Australian state or territory agency
1.10.1	number	xs:string	The number assigned by the state for previous registration of the business
1.10.2	stateTerritoryCode	xs:string	The code of the state or territory where the business name was registered previously (e.g. NSW, VIC, etc)
1.11	dateRegistered	xs:date	Date of registration for the organisation

Seq. No	XML Element	Type	Description
1.12	dateDeregistered	xs:date	Date of deregistration/cancellation – provided when the entity has been deregistered or cancelled
1.13	dateRenewal	xs:date	Date of renewal
1.14	dateReview	xs:date	Date of review - provided for registered companies
1.15	jurisdiction	xs:string	The jurisdiction under which the entity operates
1.16	address	Complex content	Contains the address for the entity if this information is public
1.16.1	type	types:addressType	Type of address. Values that may be returned in here are : GD – meaning the address for the place of business for business names GE – meaning the address for service of documents for business names RG – meaning the registered office address for a company
1.16.2	careOf	xs:string	Not relevant to this message
1.16.3	addressLine	xs:string	Contains the address details such as street number, street name, building name, etc.
1.16.4	iso3166CountryCode	xs:string	Not relevant to this message
1.16.5	country	xs:string	The name of the country according with the ISO 3166 Country Codes
1.16.6	street	Complex content	Not relevant to this message
1.16.6.1	streetNumber	xs:string	Not relevant to this message
1.16.6.2	streetName	xs:string	Not relevant to this message
1.16.6.3	streetType	xs:string	Not relevant to this message
1.16.7	locality	xs:string	Locality or suburb Must be formatted in title case (ex: North Sydney)
1.16.8	postCode	xs:string	Australian postcode
1.16.9	state	types:stateTerritoryCodeType	Australian state code with valid values: ACT; NSW; NT; QLD; SA; TAS; VIC; WA
1.16.10	override	xs:boolean	Not relevant to this message
1.16.11	action	xs:string	Not relevant to this message
1.16.12	startDate	xs:date	Not relevant to this message
1.16.13	endDate	xs:date	Not relevant to this message
1.16.14	documentNumber	types:nniNumberType	Not relevant to this message
1.17	formerName	Complex content	Details of former names of the entity
1.17.1	organisationName	types:nniNameType	Former name
1.17.2	startDate	xs:date	Date at which the former name record began
1.17.3	endDate	xs:date	Date at which the former name record ceased
1.18	recentDocument	Complex content	Contains a list of recent public documents lodged with ASIC for companies only. <i>Note: The documents related to Business Names are not public information and will not be returned in this message</i>
1.18.1	documentNumber	ascotDocumentNumberType	ASIC generated identifier to uniquely distinguish the documents lodged
1.18.2	dateReceived	xs:date	Date at which the document was accepted as fully processed by ASIC
1.18.3	formCode	xs:string	ASIC form codes – for a complete list see ASIC website: http://www.asic.gov.au/asic/asic.nsf/byheadline/Company+forms+portal?openDocument
1.18.4	numberOfPages	xs:integer	Number of pages for the pdf version of the

Seq. No	XML Element	Type	Description
			document stored in ASIC database
1.18.5	description	xs:string	The description associated with the form code
1.18.6	additionalDescription	Complex content	Contains additional information as a code and description.
1.18.6.1	subformCode	xs:string	ASIC subforms codes – for a complete list see ASIC website: http://www.asic.gov.au/asic/asic.nsf/byheadline/Company+forms+portal?openDocument
1.18.6.2	subformDescription	xs:string	The description associated with the subform code
1.19	abrEntity	Complex content	Contain ABN and name of the entity (if available)
1.19.1	abn	abnType	ABN
1.19.2	abnReferenceNumber	xs:positiveInteger	Not relevant for this message
1.19.3	entityName	orgNameType	Not relevant for this message
1.19.4	entityType	xs:string	Not relevant for this message
1.19.5	effectiveDate	xs:date	Not relevant for this message
1.20	acncFlag	xs:boolean	<p>If true, indicates that the entity is registered with the ACNC.</p> <p>It is not mandatory for this information to be displayed when presenting the result of the search. If you choose to include this information, the following text must be displayed with the result of the search:</p> <p>Registered Charity</p> <p>This company is registered as a charity with the Australian Charities and Not-for-Profits Commission (ACNC). For information on the charity, including the address for service, details of responsible persons (for example company directors) and financial reports, search the Charities register at www.acnc.gov.au.</p>

5.6. MESSAGE SPECIFICATION - queryAddress

5.6.1. Business Overview

This web service allows users to validate an Australian address entered by users in order to improve the accuracy and the integrity of the data. This service can be re-used as part of various interactions and ASIC recommends that it be used each time the user enters a new address that would update ASIC records. ASIC performs the address validation against the Postal Address File (PAF) and returns either the valid address or indicates that the address is invalid. The valid address can be the exact same address as provided in the request or it might be adjusted with minor corrections.

A valid Australian address, for ASIC purposes may include the following information: floor number, property name, unit/office number, street number, street name, street type, locality, state and postcode.

The foreign addresses are unstructured and must be provided using in four lines of text.

Postal addresses require a postal address type, postal address number (optional for some postal address types – refer to Appendix C for more information), locality, state and postcode information. Postal addresses are only supported for certain address types, namely Address for Service only.

Addresses deficient in one or more of the address elements will not pass address validation.

The reply indicates whether the address is valid or not.

5.6.2. HTTPS Connections & WSDL

Environment	WSDL
Production	https://www.gateway.asic.gov.au/gateway/ExternalQueryAddressPort?WSDL
Test	https://www.gateway.uat.asic.gov.au/gateway/ExternalQueryAddressPort?WSDL

5.6.3. queryAddress Request Message

Business Document Header

The WIG provides the specification of the Business Document Header. The following table specifies the message specific data element values or any variations to the WIG.

Element Name	Instructions / Rules	Error code
MessageType	1. Mandatory , value must be “queryAddress”	00002
MessageVersion	Mandatory , value must be 1	00004
senderType	Mandatory, value must be “REGA”	00005
senderId	The identifier assigned by ASIC on registration	00005

Business Document Body

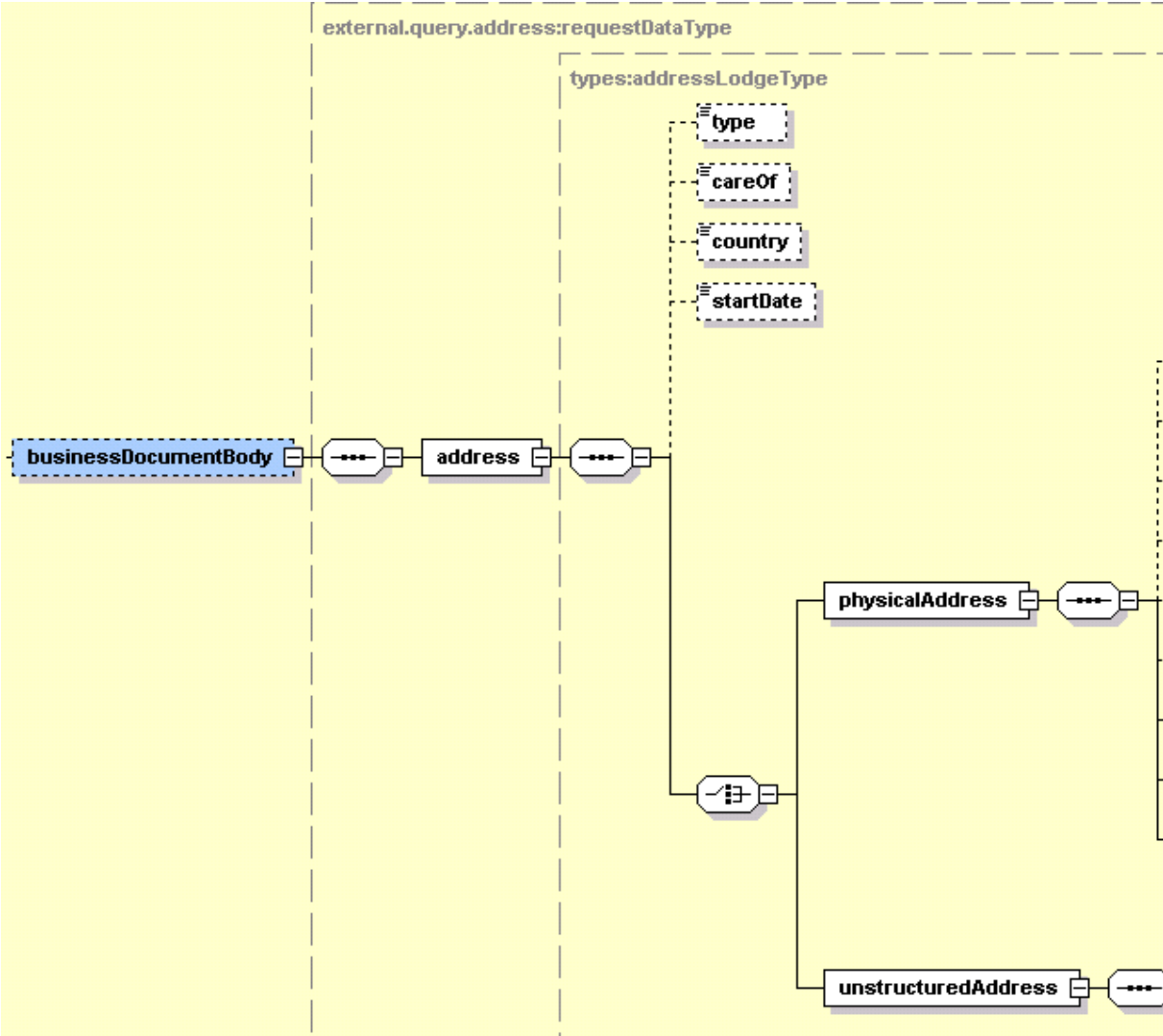

Physical address node:

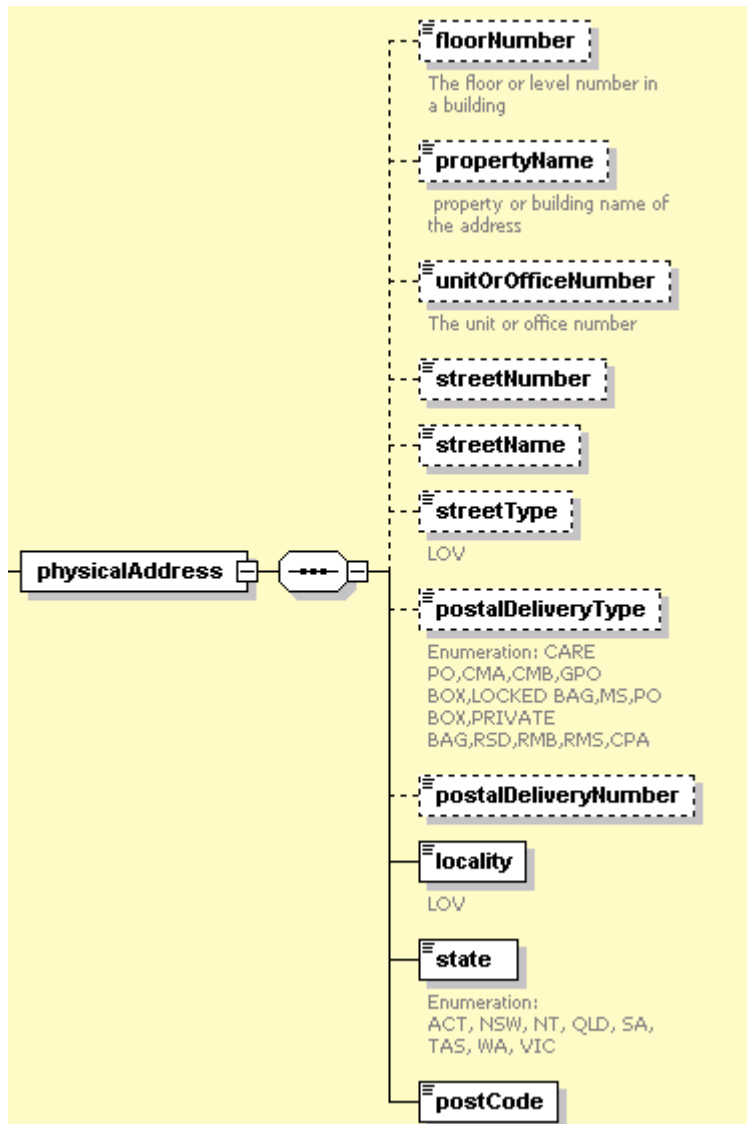

Unstructured Address node:

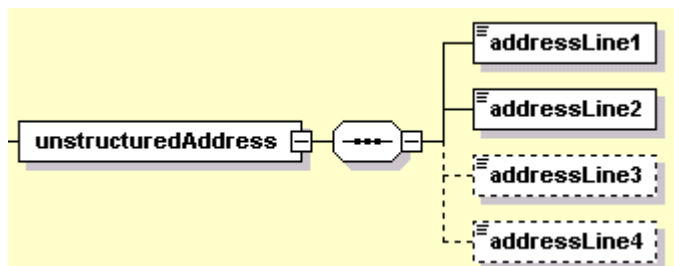

Message Content Table

Seq. No	XML Element	Type	Description
1.1	address	Complex content	The locality, postcode and state for the principal place of business(business name) or registered address (company)
1.1.1	type	types:addressType	Not relevant for this message
1.1.2	careOf	xs:string	Not relevant for this message
1.1.3	country	xs:string	Country name as per ISO3166
1.1.4	startDate	xs:date	Not relevant for this message
1.1.5	physicalAddress	Complex content	Contains the data elements required for the Australian addresses
1.1.5.1	floorNumber	xs:string	The level of the building
1.1.5.2	propertyName	xs:string	The name of the property
1.1.5.3	unitOrOfficeNumber	xs:string	The unit number
1.1.5.4	streetNumber	xs:string	The street number
1.1.5.5	streetName	xs:string	Street name
1.1.5.6	streetType	xs:string	Street type For the list of valid values please refer to Appendix C – LIST OF VALUES
1.1.5.7	postalDeliveryType	xs:string	The postal delivery type (e.g. PO Box, Locked Bag, etc) – refer to Appendix C for list of enumerations . This element is optional and only applicable to an address type of GE (Address for Service)
1.1.5.8	postalDeliveryNumber	xs:string	<ol style="list-style-type: none"> Defined in schema as Optional. This element is mandatory for only certain postalDeliveryType enumerations Refer to Appendix C for list of postalDeliveryTypes that require a postalDeliveryNumber
1.1.5.9	locality	xs:string	Locality or suburb Must be formatted in title case (ex: North Sydney)
1.1.5.10	state	types:stateTerritoryCodeType	Australian state code with valid values: ACT; NSW; NT; QLD; SA; TAS; VIC; WA
1.1.5.11	postCode	xs:string	Australian postcode
1.1.6	unstructuredAddress	Complex content	Contains the foreign addresses
1.1.6.1	addressLine1	xs:string	Mandatory - contains the details of the address such as street number, building name
1.1.6.2	addressLine2	xs:string	Mandatory - contains the details of the address such as street name, suburb, postcode.
1.1.6.3	addressLine3	xs:string	Optional
1.1.6.4	addressLine4	xs:string	Optional

5.6.4. queryAddress Reply Message Business Document Body

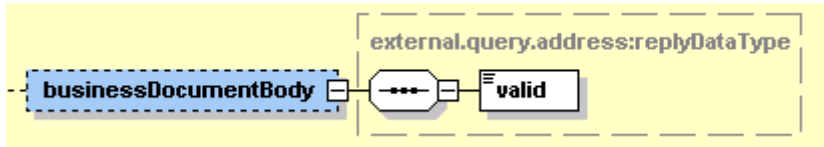

Message Content Table

Seq. No	XML Element	Type	Description
1	valid	xs:boolean	Indicator that specifies if the address provided in the request is valid. ‘TRUE’ means valid address ‘FALSE’ means the address is not valid, according with ASIC address file.

5.7. MESSAGE SPECIFICATION - bnLodgeApplication

5.7.1. Business Interaction Overview

This web service allows the lodgement of an application for registration of a Business Name. The entity applying for the business name must have a current ABN or it must have applied for an ABN and provide a valid ABR reference number (excluding the entities from Cocos Island and Christmas Island that are exempt from this requirement).

The message can be used for the following applications:

- I. registration of a new business name
- II. registration of a business name where the previous holder cancelled the business name and agreed to transfer the name to a new business name holder - in this case the applicant must be able to supply the transfer key provided by the previous holder

Request includes:

- the ABN or the ABN reference number for the entity that is applying for a business name (i.e. the holder of the business name)
- the proposed business name
- the period of registration for the new business name
- details of the business name holder applying for the new business name
- the principal place of business address
- the address for the service of documents
- email address for the ongoing contact for the business
- signatory information containing the name of the person applying for the business name
- transfer key - optionally, for names that are to be transferred

The type of data captured for a business name holder varies considerably depending on the owning entity structure. ASIC's description of these four types and the data capture matrix is shown in the table below:

ASIC Type	Description	Details collected
Individual	Person that is registered with the ABR as a sole trader	<ul style="list-style-type: none"> • Name of the holder • ABN • DOB and POB • Residential address
Incorporated body	<p>Public or private companies incorporated with ASIC or registered bodies registered with ASIC.</p> <p>Note: the Other Incorporated bodies that can't supply an ACN or ARBN will be considered 'unincorporated' for the purpose of this MIG and must provide more details upon registration (refer to "Unincorporated Structures" below)</p>	<ul style="list-style-type: none"> • Name of the holder • ABN • ACN/ARBN
Partnership	Entities that have 2 or more partners. Partnerships are typically registered with	<ul style="list-style-type: none"> • Name of the partnership • ABN

ASIC Type	Description	Details collected
	<p>the ABR.</p> <p>The partners may be:</p> <ul style="list-style-type: none"> • individuals • companies/registered bodies • other incorporated organisation without an ACN/ARBN (this will be treated as ‘unincorporated’ for the purpose of this MIG) <p>The ‘unincorporated’ structure must provide details of one or more organisation representatives that could be either a person or an incorporated body.</p>	<p><u>Details for each individual partner:</u></p> <ul style="list-style-type: none"> • Name • DOB and POB • Residential address • email (optional) <p><u>Details for each company/registered body partner:</u></p> <ul style="list-style-type: none"> • Name • ACN /ARBN • Email <p><u>Details for each organization unincorporated partner:</u></p> <ul style="list-style-type: none"> • Name • Details of individual representative (Name, DOB, POB, Residential address, email) • Details of each company/registered body that is a representative (Name, ACN/ARBN, email)
<p>Joint Venture Partnership¹</p>	<p>Joint ventures do not have a single ABN at the joint venture level. Instead each joint-venturer has an ABN.</p> <p>The partners of the joint-venture might be:</p> <ul style="list-style-type: none"> • individuals • companies/registered bodies • other organisations (must be an incorporated body, that is legal entity) without an ACN/ARBN (this will be treated as ‘unincorporated’ for the purpose of this MIG) <p>The ‘unincorporated’ structure must provide details of one or more organisation representatives that could be either a person or an incorporated body.</p>	<ul style="list-style-type: none"> • Name for the Joint-venture <p><u>Details for each individual joint-venture partner:</u></p> <ul style="list-style-type: none"> • Name • DOB and POB • Residential address • email (optional) <p><u>Details for each joint-venture company/registered body: partner:</u></p> <ul style="list-style-type: none"> • Name • ACN /ARBN • Email <p><u>Details for each joint-venture organization (unincorporated) partner:</u></p> <ul style="list-style-type: none"> • Name • Details of each individual representative (Name, DOB, POB, Residential address, email) • Details of each company/registered body that is a representative (Name, ACN/ARBN, email)
<p>Unincorporated Structures</p>	<p>All other entities that cannot be classified as one of the above (Individual, Incorporated Body or Partnership)</p> <p>For example: Trusts, Super Funds, Other unincorporated entities or Other Incorporated entities without an ACN/ARBN.</p> <p>The unincorporated structure has one or more organisation representatives that are either a person or an incorporated body.</p>	<ul style="list-style-type: none"> • Name of the holder • ABN <p><u>Details for each individual representative:</u></p> <ul style="list-style-type: none"> • Name • DOB and POB, • Residential address • email (optional) <p><u>Details for each company/registered body representative:</u></p> <ul style="list-style-type: none"> • Name • ACN /ARBN

ASIC Type	Description	Details collected
	<p>Organisation representatives must be a member of the governing body of the organisation, for example, the president, secretary or public officer of an association or other body.</p> <p>Trusts must provide details of at least one trustee.</p> <p>All notified organisation representatives will be able to update details for this business name.</p>	<ul style="list-style-type: none"> • email
<p>Christmas Island and Cocos Island entities</p>	<p>Residents of the islands that are exempted from the requirement to hold an ABN (assuming that the principle place of business will be in this jurisdiction). ASIC will treat them similarly with the partnerships and therefore details of the individual or of every partner are required.</p>	<ul style="list-style-type: none"> • Name of the holder <p><u>Details for each individual partner:</u></p> <ul style="list-style-type: none"> • Name • DOB and POB, • Residential address • email (optional) <p><u>Details for each company/registered body partner:</u></p> <ul style="list-style-type: none"> • Name • ACN /ARBN • email

Note that Joint ventures come in different structure. A joint venture entity with and ABN can be either a Partnership (which would be classified as a “partnership” via the ABR for the purposes of the BN application) a corporate structure where the joint venture partners are members of the company or a Unit Trust (which would be classified as an unincorporated entity” via the ABR for the purposes of the BN application). For the purposes of BN, we are separating these types of JVs from a group of entities that apply for a BN each with their own ABN, a “Joint Venture Partnership” for the purposes of the BN application.

The mapping between ASIC business entities and the ABR entity types to be applied in building the request messages is represented in the [Appendix A](#).

Response includes:

- result of the name assessment performed after the lodgement of the application
- the result for the lodgement that indicate if the application is accepted or rejected. If rejected it will also indicate the reasons
- URL link to the PDF of the application form

When the application is received successfully ASIC is processing it and it will confirm whether the business name can be registered or not (i.e. name is available or not). Once ASIC confirms that it can be registered and provide you with the payment details (via email), the registration fee must be paid within 10 business days or the name will be made available to the public.

When payment is received ASIC updates the public register with the new business name holder details and sends out the following correspondence:

- Payment summary
- Record of Registration
- ASIC key

ASIC will use the following channels to communicate back to the lodger:

1) Email to the business name email address contained on the request message (see below Message Content Table – XML element described in Seq. No 5

or

2) Mail to the address for service of documents (see below Message Content Table – XML element described in Seq. No 4).

5.7.2. *HTTPS Connections & WSDL*

The requestor’s code must establish a HTTPS connection to the appropriate endpoint using the standard port 443.

Environment	WSDL
Production	https://www.gateway.asic.gov.au/gateway/ExternalBz1Port?WSDL
Test	https://www.gateway.uat.asic.gov.au/gateway/ExternalBz1Port?WSDL

5.7.3. *bnLodgeApplication Request Message*

Business Document Header

The WIG provides the specification of the Business Document Header. The following table specifies the message specific data element values or any variations to the WIG.

Note that this message is updating data in ASIC register and we advise to implement the functionality described in the section ‘Duplicate transaction’ of the WIG.

Element Name	Instructions / Rules	Error code
MessageType	Mandatory, value must be “bnLodgeApplication”	00002
MessageVersion	Mandatory , value must be 1	00004
senderType	Mandatory, value must be “REGA”	00005
senderId	The identifier assigned by ASIC on registration	00005

Business Document Body

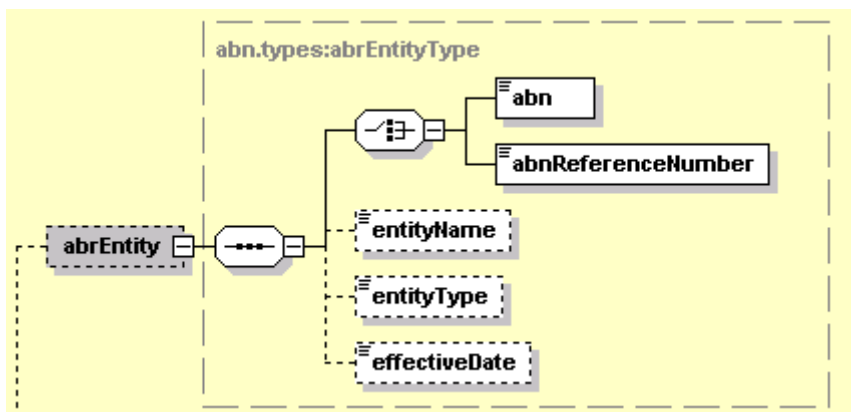
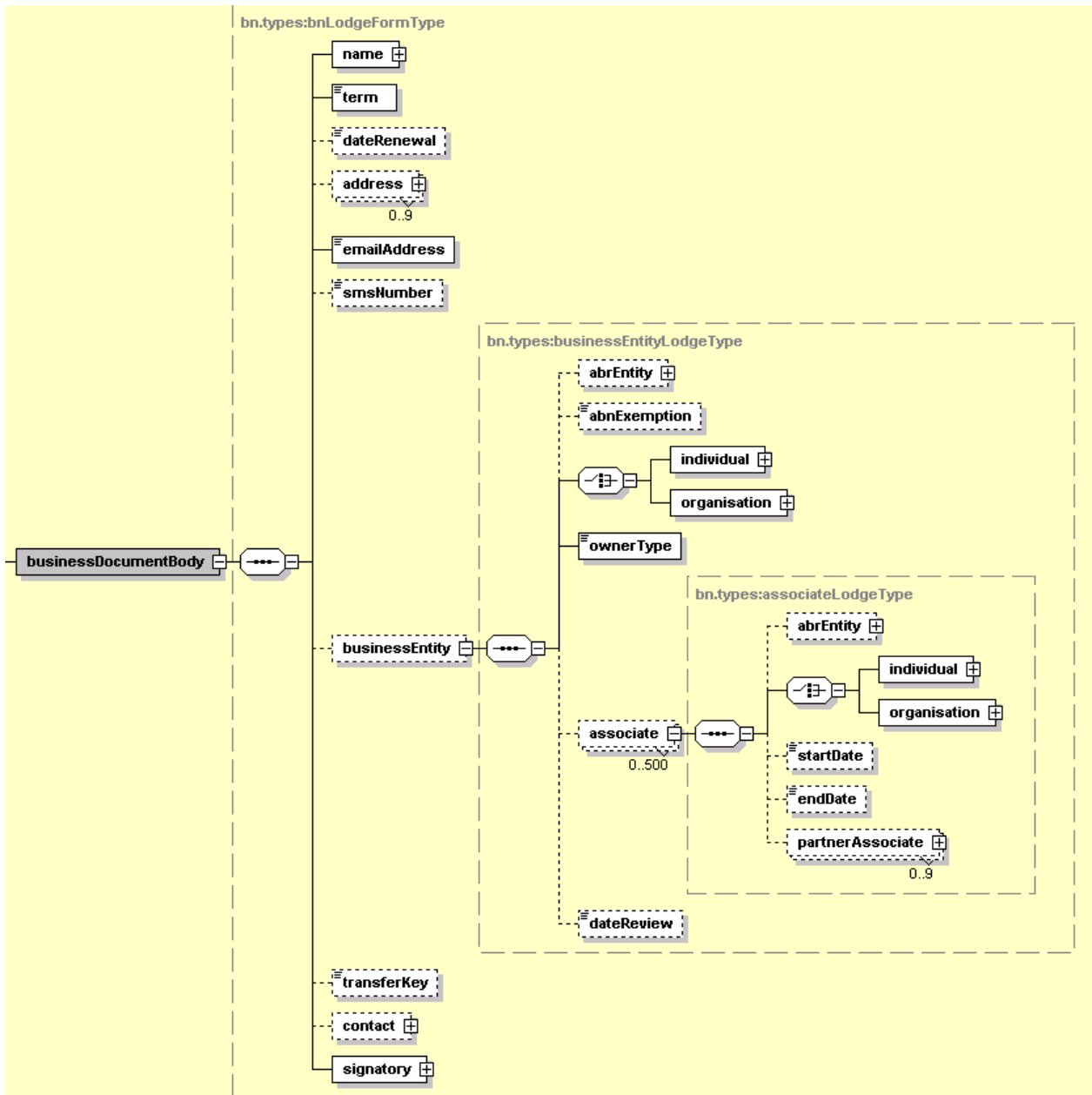

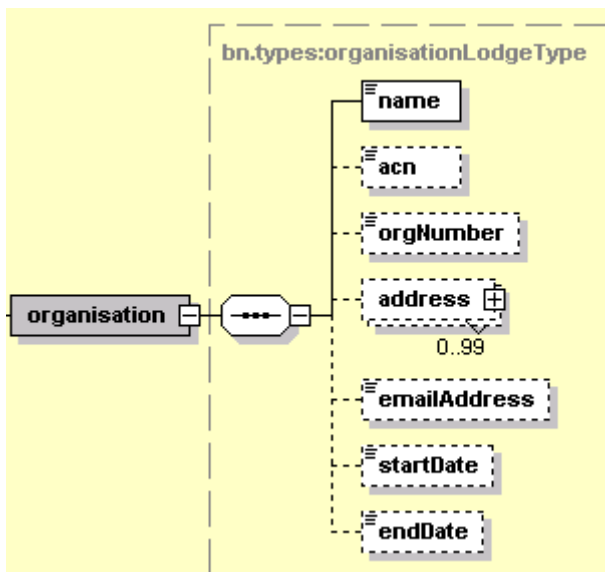
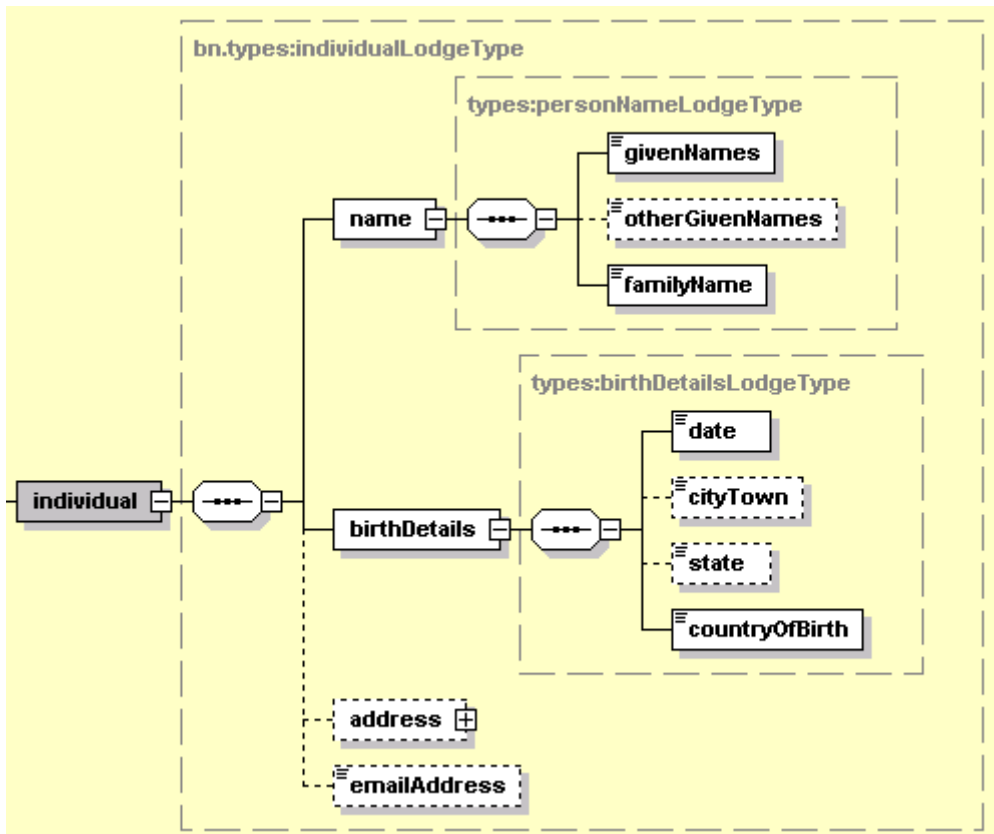

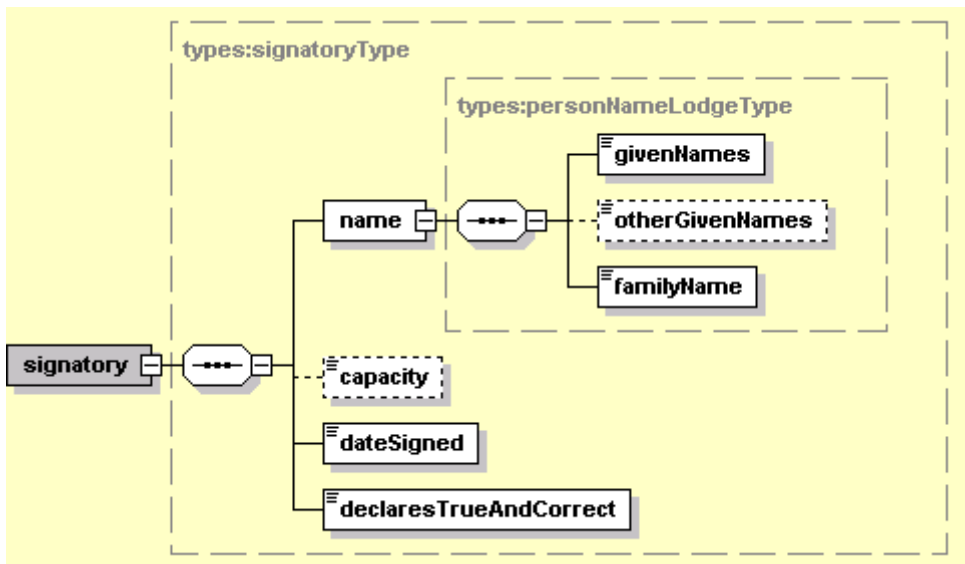
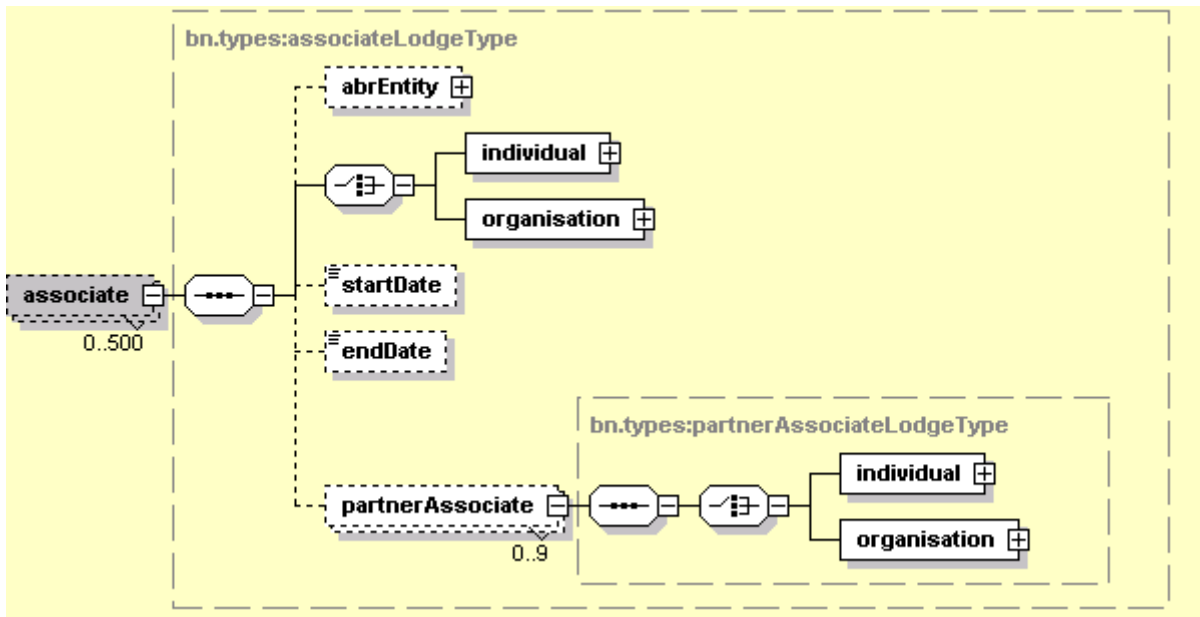

physicalAddress node

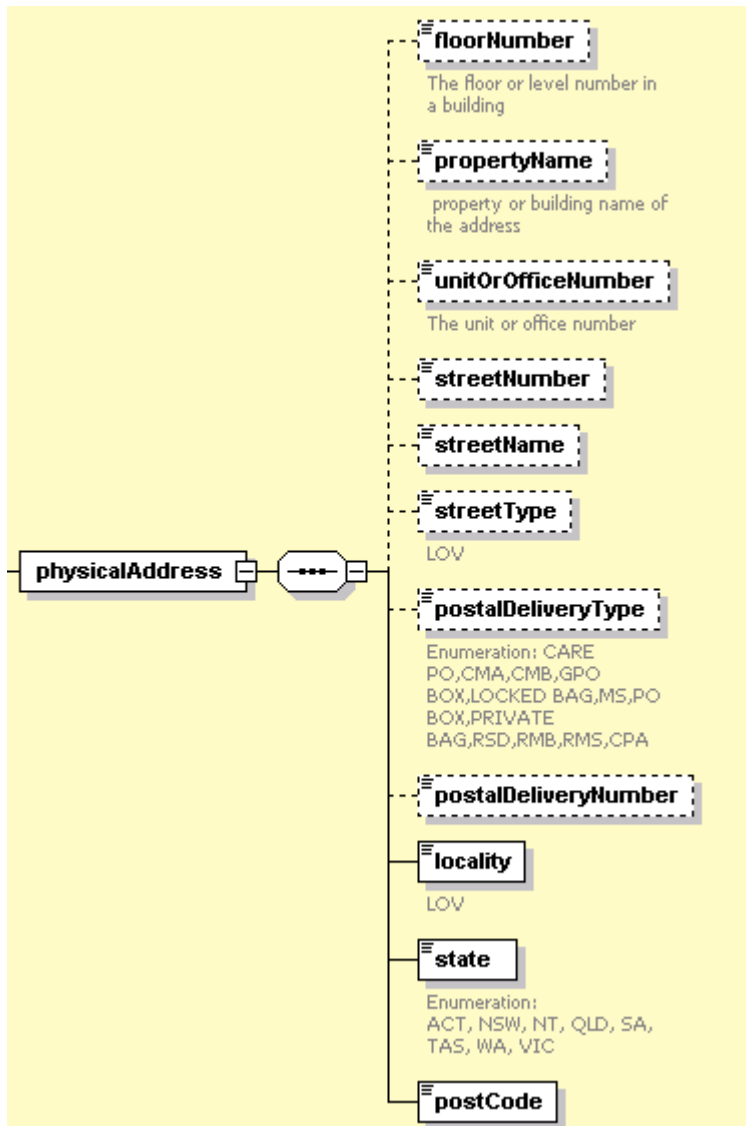

Message Content Table

Seq. No	XML Element	Type	Description	Business Rules/Instructions
1	name	Complex content	Contains the proposed business name	1. Mandatory
1.1	name	types:nniNameType	The proposed business name	1. Mandatory 2. It can contain up to valid 200 chars, including spaces. 3. Must contain valid characters: A to Z 0 to 9 ! @ # \$ % ^ & * " () ? ; : = _ - / \ . , ' { }
1.2	distinguishedWord	types:distinguishedWordType	Not relevant to this message	1. Not required
2	term	termType	The initial period of registration for the new business name that may be for one year or three years.	1. Mandatory 2. Valid values: 1 or 3
3	dateRenewal	xs:date	Renewal date, if the applicant/holder wishes to align the renewal date with a review/renewal date for another company/business name owned by same holder with the same ABN. For more information on renewal date alignment please refer to Appendix B .	1. Optional, only when the lodger want to align the renewal date of the new business name with an existing company or other business name 2. If the registration period would otherwise have been 1 year - of no more than 18 months 3. If the registration period would otherwise have been 3 years—of no more than 3 years and 6 months
4	address	Complex content	Addresses for the business such as: 1. the principal place of business address for the new business to be registered 2. address for the service of documents	1. Must be a valid address 2. Must provide the following two mandatory addresses(see valid codes below): • the principal place of business address for the new business to be registered • the service of notice address
4.1	type	types:addressType	Type of address	1. Valid values are: GD - for the address of the principal place of business

Seq. No	XML Element	Type	Description	Business Rules/Instructions
				GE – for the service of documents address
4.2	careOf	xs:string	Care Of	1. Optional
4.3	country	xs:string	Country name as per ISO3166	1. Optional. If not provided it will be defaulted to “Australia”
4.4	startDate	xs:date	The date from which the address is effective	1. Optional
4.5	physicalAddress	Complex content	Contains the data elements required for the Australian addresses	1. Mandatory 2. Both addresses must be Australian addresses
4.5.1	floorNumber	xs:string	The level of the building	1. Optional
4.5.2	propertyName	xs:string	The name of the property	1. Optional
4.5.3	unitOrOfficeNumber	xs:string	The unit number	1. Optional
4.5.4	streetNumber	xs:string	The street number	1. Optional
4.5.5	streetName	xs:string	Street name	1. Optional
4.5.6	streetType	xs:string	Street type	1. Must be a valid type - the list of valid values is available in Appendix C – LIST OF VALUES
4.5.7	postalDeliveryType	xs:string	The postal delivey type (e.g. PO Box, Locked Bag, etc)	1. Optional 2. Must be a valid type – the list of values is available in Appendix C – List of Values 3. Can only be used for address type GE (address for service)
4.5.8	postalDeliveryNumber	xs:string	The number associated with the postal delivery type	1. Defined in schema as Optional. 2. This element is mandatory for only certain postalDeliveryType enumerations 3. Refer to Appendix C for list of postalDeliveryTypes that require a postalDeliveryNumber
4.5.9	locality	xs:string	Locality or suburb	1. Mandatory 2. Must be formatted in title case (ex: North Sydney)
4.5.10	state	types:stateTerritoryCodeType	Australian state code with	1. Mandatory, valid values are: ACT; NSW; NT; QLD; SA; TAS; VIC; WA
4.5.11	postCode	xs:string	The level of the building	1. Mandatory

Seq. No	XML Element	Type	Description	Business Rules/Instructions
4.6	unstructuredAddress	Complex content	Contains the foreign addresses	1. Not applicable for principal place of business and the service of documents addresses.
4.5.1	addressLine1	xs:string	Address line 1 - may contain the details of the address such as street number, building name	1. Not required
4.5.2	addressLine2	xs:string	Address line 2 – it may contains the details of the address such as street name, suburb, postcode.	1. Not required
4.5.3	addressLine3	xs:string	Address line 3	1. Not required
4.5.4	addressLine4	xs:string	Address line 4	1. Not required
5	emailAddress	types:emailType	The email address for the business that can be used for future correspondence related to the business name. Email address is private data and it is not publically available.	1. Mandatory – the email address will be used as a preferred address for all correspondence and it is collected under ASIC’s Electronic Lodgement Protocol. For example the Record of Registration, ASIC Key and Invoice/Payment Advice for the new business name as well as notices under the BNR Act
6	smsNumber	xs:string	SMS number SMS number is private data and it is not publically available.	1. Optional. By providing a mobile number consent is given to using the number to deliver SMS messages such as alerts, reminders
7	businessEntity	complexType	Container for information related to the entity applying for the business name (business name holder)	1. Mandatory.
7.1	abrEntity	Complex content	Container for ABR information regarding the entity applying for the business name (i.e. the holder of the business name)	1. Mandatory for all entity types except the Joint-Ventures(not registered for ABN) and the residents of Christmas Island and Cocos Island
7.1.1	abn	abnType	Australian Business Number	1. One ABR identifier – ABN or ABN Reference Number must be provided. 2. Must be a valid value in ABR register. 3. The status of the entity owning the ABN in ABR register must be ‘current’.
7.1.2	abnReferenceNumber	xs:positiveInteger	ABR Reference Number provided when an application for ABN is lodged with ABR, if the ABN is not granted immediately	1. Optional - ABN Reference Number must be provided if ABN is not provided

Seq. No	XML Element	Type	Description	Business Rules/Instructions
7.1.3	entityName	orgNameType	Name of the entity applying for a business name	1. Mandatory. 2. Must match the name registered in ABR for entity types except the individuals.
7.1.4	entityType	xs:string	Entity type as recorded in ABR register for the entity applying for the business name.	1. Valid list of types as per mapping provided in Appendix A
7.1.5	effectiveDate	xs:date	The date recorded in ABR as effective date for the ABN	1. Must match ABR records
7.2	abnExemption	types:trueType	Indicates that the holder is exempted from holding an ABN under one of the two scenarios: <ul style="list-style-type: none"> • joint-venture or • Christmas Island and Cocos islands entities 	1. Valid value is 'true' if holder is exempted from holding an ABN (i.e. the entities type Joint-Venture or the entities from Cocos Islands and Christmas Island
7.3	individual	Complex content	Container for information required for the holder applying for the business name when the legal entity is 'Individual' (sole trader)	1. Conditional as follows: <ul style="list-style-type: none"> • Mandatory when the holder type is individual • Not required for all other entity type (e.g. companies, partnerships, JV, trusts)
7.3.1	name	types:personNameType	Container for the name of the individual (sole trader) applying for the business name	1. Mandatory
7.3.1.1	givenNames	xs:string	Given name of the individual	1. Mandatory
7.3.1.2	otherGivenNames	xs:string	Other given names	1. Optional
7.3.1.3	familyName	xs:string	Family name of the individual	1. Mandatory
7.3.2	birthDetails	Complex content	Container for the birth details of the individual applying for the business name Birth details is private data and it is not publically available.	1. Mandatory
7.3.2.1	date	xs:date	Date of birth	1. Mandatory 2. Must be a date before current date
7.3.2.2	cityTown	xs:string	Locality/city/town of birth	1. Optional 2. Must be formatted in title case (ex: North

Seq. No	XML Element	Type	Description	Business Rules/Instructions
				Sydney)
7.3.2.3	state	xs:string	State code for the state of birth, if in Australia.	1. Optional. 2. Valid values: <i>ACT; NSW, NT; QLD; SA; TAS; VIC; WA</i>
7.3.2.5	countryOfBirth	xs:string	Country name for country of birth	1. Mandatory
7.3.3	address	Complex content	The physical address of the individual who is the holder of the business name	1. Mandatory
7.3.3.1	type	types:addressType	Type of address	1. Must be “ GC ” (meaning Business Name Individual Residential Address)
7.3.3.2	careOf	xs:string	To be used for intermediary details that may be added to mail addresses as ‘care of’ (c/-)	1. Not required
7.3.3.3	country	xs:string	Country name as per ISO3166	1. Optional. If not provided it will be defaulted to “Australia”
7.3.3.4	startDate	xs:date	The date from which the address is effective	1. Optional
7.3.3.5	physicalAddress	Complex content	Contains the data elements required for the Australian addresses	1. Conditional – must be used if the residential address is an Australian address
7.3.3.5.1	floorNumber	xs:string	The level of the building	1. Optional
7.3.3.5.2	propertyName	xs:string	The name of the property	1. Optional
7.3.3.5.3	unitOrOfficeNumber	xs:string	The unit number	1. Optional
7.3.3.5.4	streetNumber	xs:string	The street number	1. Optional
7.3.3.5.5	streetName	xs:string	Street name	1. Optional
7.3.3.5.6	streetType	xs:string	Street type	1. Must be a valid type - the list of valid values is available in Appendix C – LIST OF VALUES
7.3.3.5.7	locality	xs:string	Locality or suburb	1. Mandatory 2. Must be formatted in title case (ex: North Sydney)
7.3.3.5.8	state	types:stateTerritoryCodeType	Australian state code	1. Mandatory, valid values are: <i>ACT; NSW; NT; QLD; SA; TAS; VIC; WA</i>
7.3.3.5.9	postCode	xs:string	Australian postcode	1. Mandatory
7.3.3.6	unstructuredAddress	Complex content	Container for the foreign address	1. Conditional – must be used if the residential address is an foreign address

Seq. No	XML Element	Type	Description	Business Rules/Instructions
7.3.3.6.1	addressLine1	xs:string	Mandatory - contains the details of the address such as street number, building name	1. Mandatory
7.3.3.6.2	addressLine2	xs:string	Mandatory - contains the details of the address such as street name, suburb, postcode.	1. Mandatory
7.3.3.6.3	addressLine3	xs:string	Optional	1. Optional
7.3.3.6.4	addressLine4	xs:string	Optional	1. Optional
7.3.4	emailAddress	types:emailType	The email address of the individual holder of the business name. Email address is private data and it is not publically available.	1. Optional
7.4	organisation	Complex content	Container for information required for the holder applying for the business name when the legal entity is any of the types except 'Individual' (sole trader)	1. Conditional as follows: <ul style="list-style-type: none"> • Mandatory for all holder types except individual (e.g. companies, partnerships, JV, trusts) • Not required for individuals holders
7.4.1	name	nniNameType	The legal name of the company applying for the business name	1. Mandatory. 2. Must match the name as per ASIC records.
7.4.2	acn	nniNumberType	The ACN of the company applying for the business name	1. Conditional as follows: <ul style="list-style-type: none"> • Mandatory for incorporated bodies • Not required for any other type of holder. 2. Must comply with the ACN algorithm. 3. Must belong to company that exists in ASIC register. 4. Must belong to a company with status 'registered in ASIC register'
7.4.3	orgNumber	xs:string	Not relevant to this message	1. Not required
7.4.4	address	complexType	Not relevant to this message	1. Not required
7.4.5	emailAddress	types:emailType	The email address of the entity that is company/registered body that applies for the business name	1. Optional

Seq. No	XML Element	Type	Description	Business Rules/Instructions
7.4.6	startDate	xs:date	Not relevant to this message	1. Not required
7.4.7	endDate	xs:date	Not relevant to this message	1. Not required
7.5	ownerType	xs:string	Indicates the type of holder, according with ASIC types.	1. Valid values are: IND – for individual holder (sole trader) IB – for incorporated bodies (e.g. private or public companies) PTSH – for partnerships USTR – for unincorporated entities (e.g. trusts, associations, coops) JV – for the joint-ventures
7.6	associate	Complex content	Contains the information related to each person or company that represents the business name holder. Note: the term ‘associate’ does not have any legal meaning (it represents a container of data) and it should not be used on the UI. We suggest the user interfaces to display the correct description according with the holder type. For example: partners of the partnership, joint-venture partners in a joint-venture, trustees in a trust.	1. Conditional as follows: 1) Mandatory if the holder is an unincorporated structure, a partnership or a joint-venture. IF the entity type = PTSH (partnership) or JV (Joint venture): It must contain the partner’s details of the partnership or in a joint-venture IF the entity type = USTR (unincorporated entities): It must contain the organisation representatives details for the entity (for example the trustees) 2) Not required if holder ‘Individual’ or ‘incorporated body’ (e.g. companies)
7.6.1	abrEntity	Complex content	Container for ABR information for the joint-venture partner or other entity type	1. Conditional as follows: <ul style="list-style-type: none"> • Mandatory if the entity is a Joint-Venture • Optional for all entity types except the Joint-Venture type
7.6.1.1	abn	abnType	ABN	1. Mandatory
7.6.1.2	abnReferenceNumber	xs:positiveInteger	ABR Reference Number provided when an application for ABN is lodged with ABR, if	1. Not required

Seq. No	XML Element	Type	Description	Business Rules/Instructions
			the ABN is not granted straight away	
7.6.1.3	entityName	orgNameType	Not relevant to this message	Not required
7.6.1.4	entityType	xs:string	Not relevant to this message	1. Not required
7.6.1.5	effectiveDate	xs:date	Not relevant to this message	1. Not required
7.6.2	individual	Complex content	Contains information related to the persons that represent the holder of the business name (e.g. partners, individual trustees, individuals partners in a Joint-Venture)	1. Conditional as follows: <ul style="list-style-type: none"> • Mandatory if the partner/trustee is a person (e.g. individual partner, individual trustee, individual Joint-Venturer.) • Not required if the partner/trustee is an organisation (either incorporated or unincorporated)
7.6.2.1	name	types:personNameType	Container for the name of the person representing the business name holder	1. Mandatory
7.6.2.1.1	givenNames	xs:string	Given name of the individual	1. Mandatory
7.6.2.1.2	otherGivenNames	xs:string	Other given names	1. Optional
7.6.2.1.3	familyName	xs:string	Family name of the individual	1. Mandatory
7.6.2.2	birthDetails	Complex content	Birth details for the person representing the business name holder. Birth details are private data and it is not publically available.	1. Mandatory
7.6.2.2.1	date	xs:date	Date of birth	1. Mandatory 2. Must be a date before current date
7.6.2.2.2	cityTown	xs:string	Locality/city/town of birth	1. Optional 2. Must be formatted in title case (ex: North Sydney)
7.6.2.2.3	state	xs:string	State code for the state of birth, if in Australia.	1. Optional. 2. Valid values: ACT; NSW, NT; QLD; SA; TAS; VIC; WA
7.6.2.2.4	countryOfBirth	xs:string	Country name for country of birth	1. Mandatory
7.6.2.3	address	Complex content	Residential address of the person representing the business name holder (e.g.	1. Mandatory

Seq. No	XML Element	Type	Description	Business Rules/Instructions
			partner, trustee, etc)	
7.6.2.3.1	type	types:addressType	Type of address	1. Value must be “GC” (meaning Residential Address)
7.6.2.3.2	careOf	xs:string	‘Care of’ (c/-)	Not required
7.6.2.3.3	country	xs:string	Country name as per ISO3166	1. Optional. If not provided it will be defaulted to “Australia”
7.6.2.3.4	startDate	xs:date	The date from which the address is effective	1. Optional
7.6.2.3.5	physicalAddress	Complex content	Contains the data elements required for the Australian addresses	1. Conditional – must be used if the residential address is an Australian address
7.6.2.3.5.1	floorNumber	xs:string	The level of the building	1. Optional
7.6.2.3.5.2	propertyName	xs:string	The name of the property	1. Optional
7.6.2.3.5.3	unitOrOfficeNumber	xs:string	The unit number	1. Optional
7.6.2.3.5.3	streetNumber	xs:string	The street number	1. Optional
7.6.2.3.5.4	streetName	xs:string	Street name	1. Optional
7.6.2.3.5.5	streetType	xs:string	Street type	1. Must be a valid type - the list of valid values is available in Appendix C – LIST OF VALUES
7.6.2.3.5.6	locality	xs:string	Locality or suburb	1. Mandatory 2. Must be formatted in title case (ex: North Sydney)
7.6.2.3.5.7	state	types:stateTerritoryCodeType	Australian state code	1. Mandatory, valid values are: ACT; NSW; NT; QLD; SA; TAS; VIC; WA
7.6.2.3.5.8	postCode	xs:string	Australian postcode	1. Mandatory
7.6.2.3.6	unstructuredAddress	Complex content	Contains the foreign addresses	1. Conditional – must be used if the residential address is an foreign address
7.6.2.3.6.1	addressLine1	xs:string	Mandatory - contains the details of the address such as street number, building name	1. Mandatory
7.6.2.3.6.2	addressLine2	xs:string	Mandatory - contains the details of the address such as street name, suburb, postcode.	1. Mandatory
7.6.2.3.6.3	addressLine3	xs:string	Address line 3	1. Optional

Seq. No	XML Element	Type	Description	Business Rules/Instructions
7.6.2.3.6.4	addressLine4	xs:string	Address line 4	1. Optional
7.6.2.4	emailAddress		Email address for the person (e.g. partner, trustee, etc) Email address is private data and it is not publically available.	1.Optional
7.6.3	organisation	Complex content	Contains the information related to the organisations (e.g. partner, trustee) representing the business name holder	1. Conditional as follows: <ul style="list-style-type: none"> • Mandatory if the entity is a an organisation (either incorporated or unincorporated) • Not required if person (e.g. individual partner, individual trustee, individual Joint-Venturer.)
7.6.3.1	name	types:nniNameType	The legal name of the incorporated entity	1. Mandatory. 2. Must match the name as per ASIC records.
7.6.3.2	acn	types:nniNumberType	The ACN of the company	1. Mandatory. 2. Must comply with the ACN algorithm. 3. Must belong to company that exists in ASIC register. 4. Must belong to a company with status 'registered'.
7.6.3.3	orgNumber	xs:string	Not relevant to this message	1. Not required
7.6.3.4	address	complexType	Not relevant to this message	1. Not required
7.6.3.5	emailAddress	types:emailType	Email address of the company Email address is private data and it is not publically available.	1. Optional
7.6.3.6	startDate	xs:date	Not relevant to this message	1. Not required
7.6.3.7	endDate	xs:date	Not relevant to this message	1. Not required
7.6.4	startDate	xs:date	Not relevant to this message	1. Not required
7.6.5	endDate	xs:date	Not relevant to this message	1. Not required
7.6.6	partnerAssociate	Complex content	Contains information related to the individuals or companies that are the organisation representatives of a partner of	1. Conditional as follows: <ul style="list-style-type: none"> • Required when business name holder a partnership/joint-venture and one of the partners

Seq. No	XML Element	Type	Description	Business Rules/Instructions
			<p>joint-venture. It applies only to partners or joint-venture partners that are 'unincorporated' organisations.</p> <p>Note: the term 'partnerAssociate' does not have any legal meaning (it represents a container of data) and it should not be used on the UI. We suggest the user interfaces to display the correct description (for example: organisation representative).</p>	<p>is an 'unincorporated' entity (e.g. a trust): It must contain details for at least one organisation representative (person or organisation)</p> <ul style="list-style-type: none"> • Not required for other types of holders or for the partners/joint-venture partners are either persons or incorporated entities.
7.6.6.1	individual	Complex content	Contains information related to the person who is organisation representative for a partner or joint-venture partner of type 'unincorporated' (e.g. trustee of the trust)	Conditional as per above.
7.6.6.1.1	name	types:personNameType	Container for the name of the person.	1. Mandatory.
7.6.6.1.1.1	givenNames	xs:string	Given name of the individual	1. Mandatory.
7.6.6.1.1.2	otherGivenNames	xs:string	Other given names	
7.6.6.1.1.3	familyName	xs:string	Family name of the individual	1. Mandatory.
7.6.6.1.2	birthDetails	Complex content	<p>The birth details for the person who is organisation representative for a partner or joint-venture partner of type 'unincorporated' (e.g. trustee of the trust).</p> <p>Birth details is private data and it is not publically available.</p>	1. Mandatory
7.6.6.1.2.1	date	xs:date	Date of birth	1. Mandatory
7.6.6.1.2.2	cityTown	xs:string	Locality/city/town of birth	1. Optional 2. Must be formatted in title case (ex: North Sydney)
7.6.6.1.2.3	state	xs:string	State code for the state of birth, if in Australia.	1.Optional
7.6.6.1.2.4	countryOfBirth	xs:string	Country name for country of birth	1.Optional

Seq. No	XML Element	Type	Description	Business Rules/Instructions
7.6.6.1.3	address	Complex content	Residential address for the person who is organisation representative for a joint-venture partner type 'unincorporated' structure (e.g. trustee of the trust)	1. Mandatory
7.6.6.1.3.1	type	types:addressType	Type of address	1. Must be type = "GC" (meaning Individual Residential Address)
7.6.6.1.3.2	careOf	xs:string	'care of' (c/-)	1. Not required
7.6.6.1.3.3	country	xs:string	Country name as per ISO3166	1. Optional. If not provided it will be defaulted to "Australia"
7.6.8.1.4.4	startDate	xs:date	The date from which the address is effective	1. Optional
7.6.6.1.3.5	physicalAddress	Complex content	Contains the data elements required for the Australian addresses	1. Conditional – must be used if the residential address is an Australian address
7.6.6.1.3.5.1	floorNumber	xs:string	The level of the building	1. Optional
7.6.6.1.3.5.2	propertyName	xs:string	The name of the property	1. Optional
7.6.6.1.3.5.3	unitOrOfficeNumber	xs:string	The unit number	1. Optional
7.6.6.1.3.5.4	streetNumber	xs:string	The street number	1. Optional
7.6.6.1.3.5.5	streetName	xs:string	Street name	1. Optional
7.6.6.1.3.5.6	streetType	xs:string	Street type	1. Must be a valid type - the list of valid values is available in Appendix C – LIST OF VALUES
7.6.6.1.3.5.7	locality	xs:string	Locality or suburb	1. Mandatory 2. Must be formatted in title case (ex: North Sydney)
7.6.6.1.3.5.8	state	types:stateTerritoryCodeType	Australian state code with valid values: ACT; NSW; NT; QLD; SA; TAS; VIC; WA	1. Mandatory, valid values are: ACT; NSW; NT; QLD; SA; TAS; VIC; WA
7.6.6.1.3.5.9	postCode	xs:string	Australian postcode	1. Mandatory
7.6.6.1.3.6	unstructuredAddress	Complex content	Contains the foreign addresses	1. Conditional – must be used if the residential address is an foreign address
7.6.6.1.3.6.1	addressLine1	xs:string	Mandatory - contains the details of the address such as street number, building name	1. Mandatory
7.6.6.1.3.6.2	addressLine2	xs:string	Mandatory - contains the details of the	1. Mandatory

Seq. No	XML Element	Type	Description	Business Rules/Instructions
			address such as street name, suburb, postcode.	
7.6.6.1.3.6.3	addressLine3	xs:string	Address line 3	1. Optional
7.6.6.1.3.6.4	addressLine4	xs:string	Address line 4	1. Optional
7.6.6.1.4	emailAddress	xs:string	Email address of the person who is the organisation representative for a joint-venture partner type 'unincorporated' structure (e.g. trustee of the trust). Email address is private data and it is not publically available.	1. Optional
7.6.6.2	organisation	Complex content	Contains information related to the company/body corporate that is organisation representative for a partner or joint-venture partner type 'unincorporated' structure (e.g. corporate trustee of the trust)	1. Conditional as per rules for 'partnerAssociate'
7.6.6.2.1	name	types:nniNameType	The legal name of the company that is legal representative for a partner/JV partner type 'unincorporated' structure (e.g. corporate trustee of the trust)	1. Mandatory.
7.6.6.2.2	acn	types:nniNumberType	The ACN of the company that is legal representative for a partner/JV partner type 'unincorporated' structure (e.g. corporate trustee of the trust)	1. Mandatory. 2. Must comply with the ACN algorithm. 3. Must belong to company that exists in ASIC register. 4. Must belong to a company with status 'registered'.
7.6.6.2.3	address	complexType	Not relevant to this message	1. Not required
7.6.6.2.4	emailAddress	types:emailType	The email address for the company that is organisation representative for a partner/joint-venture partner type 'unincorporated' structure (e.g. corporate trustee of the trust). Email address is private data and it is not publically available.	1. Optional

Seq. No	XML Element	Type	Description	Business Rules/Instructions
7.6.6.2.5	startDate	xs:date	Not relevant to this message	1. Not required
7.6.6.2.6	endDate	xs:date	Not relevant to this message	1. Not required
7.7	dateReview	xs:date	Not relevant to this message	1. Not required
8	transferKey	types:keyType	Identifier issued by ASIC for the business names that have been cancelled with the intent to transfer them to another holder	1. Must be a valid transfer key issued by ASIC
9	contact	Complex content	Not required	1. Not required
10	signatory	Complex content	To be used for the information related with the person signing for the application	1. Mandatory
10.1	name	Complex content	Name of the person 'signing' meaning that has authorised the lodgement	1. Mandatory
10.1.1	givenNames	xs:string	Given name of the person	1. Mandatory
10.1.2	otherGivenNames	xs:string	Other given names	1. Optional
10.1.3	familyName	xs:string	Family name of the individual	1. Mandatory.
10.2	capacity	xs:string	To be used for the capacity (position) of the person signing the declaration	1. Not required
10.3	dateSigned	xs:date	Date of declaration	1. Use 'current' date
10.4	declaresTrueAndCorrect	types:trueType	Indicates that user has read and agreed with the statements presented in the 'Declaration', 'Authority' and 'Eligibility' sections (refer to section 3 <i>Signatory</i>)	1. Must be 'true' or '1'

5.7.4. bnLodgeApplication Reply Message

Business Document Header

The WIG provides the standard specification of the Business Document Header. The following table specifies the message level specific data element values or any variations to the WIG.

Element Name	Instructions / Rules
MessageType	1. Mandatory, value is "bnLodgeApplication"
Attachments -> Attachment	1. Provided when the lodgement is successful 2. Contains the URL links for the PDF files produced by ASIC as a proof of lodgment. The requestor should be able to print/save the document as future reference.
documentType	1. Mandatory.
URL	1. URL link to the PDF file produced by ASIC as a proof of lodgment
asicTransactionNumber	1. Mandatory – transaction unique identifier assigned by ASIC for this transaction

Business Document Body

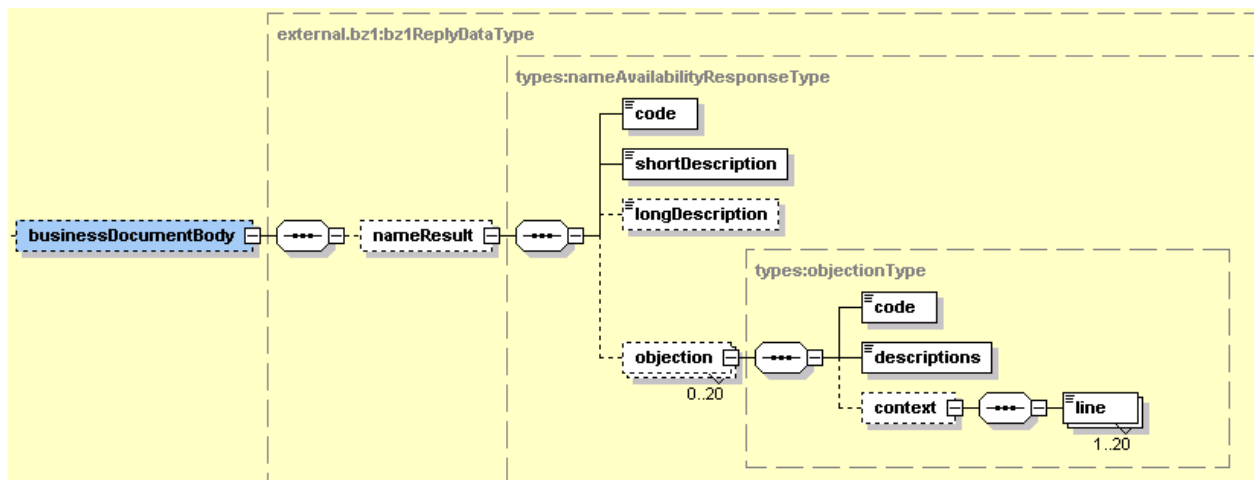

Message Content Table

Seq. No	XML Element	Type	Description
1	nameResult	Complex content	Indicates the result of the name assessment for the proposed business upon submitting the application. This validation is same with the validation done using the queryNameAvailability service.
1.1	code	xs:string	Will return one of the following valid values : Available –the name is available to be used as a

Seq. No	XML Element	Type	Description
			<p>business name</p> <p>Unavailable –the name can't be used and the user should propose another name</p> <p>SubjectToNamesDetermination –the name is referred to ASIC staff for manual determination</p> <p>UnderTransfer –the name has been previously cancelled with the intention to transfer to another holder</p> <p>Identical – meaning the name is identical to another name and it may be rejected or referred to manual determination</p>
1.2	shortDescription	xs:string	A short text description associated with the code (as listed above) and it provides the result of the name availability check done as part of the validations for the application being submitted
1.3	longDescription	xs:string	A long text description associated with the codes (as listed above) and it provides the result of the name availability check done as part of the validations for the application being submitted
1.4	objections	Complex content	Returned only when the proposed name is unavailable or it is subject to name determination. It contains a code and a description and indicates the reason for the decision.
1.4.1	code	xs:string	<p>The code used by ASIC for the objections. It is returned only if the name is unavailable or is referred to manual processing.</p> <p>Examples (code - description) of some common objections:</p> <p>ABORCORP - objectionable without consent of minister</p> <p>AVBLRSV - identical to a defunct reserved name</p> <p>BUSSNAME - name is identical to a registered business name</p> <p>CAVTNAME - name is identical to existing name caveat</p> <p>CAVTWORD - name contains existing word caveat</p> <p>CNCLRSV - identical to a cancelled reserved name</p> <p>COMMONWTH - unacceptable unless used geographically</p> <p>CONCROWN - objectionable unless connection to crown exists</p> <p>CONDEPMT - objectionable unless connection with depts exists</p> <p>CONDOMIN - objectionable unless connection exists</p> <p>CONFEDRL- name suggests connection with federal government</p> <p>CONFORGN - suggests connection with foreign government</p> <p>CONGOVT - suggests connection with state or federal govt</p> <p>CONMUNIC - suggests connection with municipal council etc.</p> <p>CONROYAL - suggests connection with member of royal</p>

Seq. No	XML Element	Type	Description
			<p>family CONSERVS - suggests connection with exservicemens organsn CONSTATE - suggests connection with state/territory govt EXISTAPL - identical to a current reserved business name EXISTCOY- identical to an already registered corporation EXISTLCA- identical to a s150 or consent application EXISTRSV - identical to a current reserved name INVCHARS - name contains invalid characters MEMBHCAP - name suggests members are incapacitated OBJANZAC - object without consent of min for veteran affairs OBJBRADM - suggests a connection with Sir Donald Bradman OBJCHAMB - objectionable without consent of minister OBJEXSV - obj phrase - rsl, returned services league OBJPOLI1 - suggests a connection with the police OBJSIMLR- similar to existing.may require further info s1274 OBJS1115 - name contains proscribed phrase under s1115 cl OBJTBANK - name restricted without consent of APRA OBJTCOOP- restricted unless corp is a cooperative society OBJTDEFN - object without consent of minister for defence OBJTUNAT- object without consent of min for foreign affairs OBJTUNIV - object without consent of minister for education OFFENSIV - offensive to public or group of public PATROYAL - suggests royal patronage has been given UNACCEPT - name is considered unacceptable</p> <p>Please note that is best to develop a generic process to display the code and description as opposed to hard coding these. ASIC may in time choose to tweak or embellish upon the objection descriptions.</p>
1.4.2	description	xs:string	The description associated with the code of the objections.
1.4.3	context	complexType	Additional information returned when the name is identical or near identical to another existing name.
1.4.3.1	line	xs:string	Contains the ASIC internal identifier for a business name or Australian Company Number and the company name that resulted in the exact match (i.e. the existing registered name).

6. MAINTAINING A BUSINESS NAME

The following service is now available to support the ongoing maintenance of a Business name:

- Business name renewal with a request for the renewal fee to be invoiced.

6.1. PREREQUISITES

In addition to the conditions listed in section 4.2 Prerequisites:

- The Authorised Lodger must have authorisation from the BN holder of the Business name to submit the BN renewal on their behalf.

6.2. SERVICE SUMMARY

	Service Name	Mandatory	Repeatable
1.	<p>bnRenewal</p> <p>This service allows an authorised lodger to select a renewal period; update the BN contact email address and request for the renewal fee to be invoiced.</p>	Yes	No

6.3. MESSAGE SPECIFICATION - BNRENEWAL

6.3.1. Business Overview

This web service provides the functionality to renew a business name. Upon lodging the request successfully:

- The business name registration renewal is invoiced for 1 or 3 years;
- If the email address provided is different to the contact email address against the Business name, the contact email address will be updated; and
- An invoice will be provided to the business name holder via email at the contact email address provided.

The business name holder or the authorised lodger must pay the renewal fee before the business name renewal is complete. On completion, ASIC will send via email the:

- ✓ Record of Registration; and
- ✓ Payment Confirmation.

6.3.2. *HTTPS Connections & WSDL*

Environment	WSDL
Production	https://www.gateway.asic.gov.au/gateway/ExternalBnRenewalPort?WSDL
Test	https://www.gateway.uat.asic.gov.au/gateway/ExternalBnRenewalPort?WSDL

6.3.3. *bnRenewal Request Message*

Business Document Header

The WIG provides the specification of the Business Document Header. The following table specifies the message specific data element values or any variations to the WIG.

Element Name	Instructions / Rules	Error code
MessageType	Mandatory, value must be "bnRenewal"	00002
MessageVersion	Mandatory , value must be 1	00004
senderType	Mandatory, value must be "REGA"	00005
senderId	The identifier assigned by ASIC on registration	00005

Business Document Body

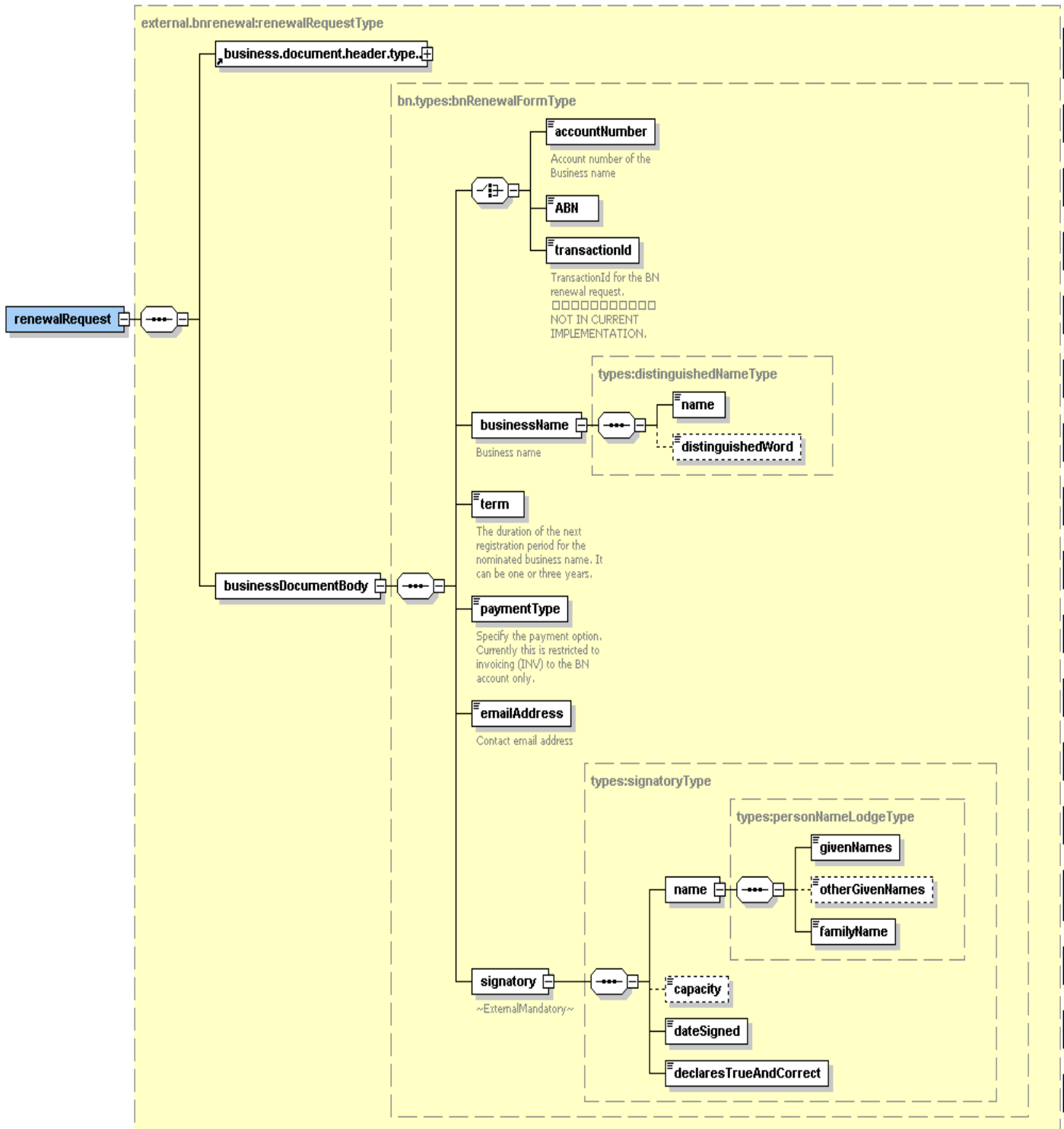

Message Content Table

Seq. No	XML Element	Type	Description	Business Rules/Instructions
1.1	accountNumber	types:accountNumberType	The ASIC account number for the business name	<ol style="list-style-type: none"> Optional The account number is available on all BN renewal letters. The account number is 11 digits. The account number is the 9 digit nniNumber with 85 in front of it. If the nniNumber has fewer than 9 digits insert leading zeroes to make it 9 digits. For example, the account number for nniNumber 14526933 is 85014526933. The account number must be linked to a current business name. There must be an outstanding renewal for this business name.
1.2	abn	abnType	Australian Business Number	<ol style="list-style-type: none"> Optional Must provide ABN or account number Must be a valid value in ABR register. Must be a linked ABN on the BN register. There must be an outstanding renewal for this business name.
1.3	transactionId	types:transactionIdType	A unique identifier for the BN renewal transaction.	1. Not required
2	businessName	Complex content	Contains the business name	6. Mandatory
2.1	name	types:nniNameType	The business name to be renewed	<ol style="list-style-type: none"> Mandatory If the account number is provided, this name must match the business name of the account provided. If the ABN is provided, the ABN must be associated with the holder of this BN.
2.2	distinguishedWord	types:distinguishedWordType	Not relevant to this message	1. Not required

Seq. No	XML Element	Type	Description	Business Rules/Instructions
3	term	bn.types	The duration of the next registration period for the nominated business name.	1. Mandatory 2. Valid values are 1 or 3; to indicate the renewal period of 1 or 3 years correspondingly.
4	paymentType	types:paymentMethodType	Indicates the payment method for the BN renewal fee.	1. Mandatory 2. Enter 'INV' for invoice.
5	emailAddress	types:emailType	Contact email address for the Business name Email address is private data and it is not publically available.	1. Mandatory 2. Must contain one and only one "@" character. 3. It's a requirement to provide the following text on the user interface: 'The email address provided will replace any existing email addresses against the business name. The address supplied will now receive all issued notifications.'
6	Signatory	Complex content	To be used for the information related with the person signing this lodgement	1. Mandatory
6.1	name	Types:personNameLodgeType	Name of the business name owner or authorised lodger signing this declaration	1. Mandatory
6.1.1	givenNames	xs:string	Given name of the person	1. Mandatory
6.1.2	otherGivenNames	xs:string	Other given names	1. Optional
6.1.3	familyName	xs:string	Family name of the individual	1. Mandatory.
6.2	capacity	xs:string	To be used for the capacity (position) of the person signing the declaration	1. Not required
6.3	dateSigned	xs:date	Date of declaration	1. Use 'current' date
6.4	declaresTrueAndCorrect	types:trueType	Indicates that user has read and agreed with the statements presented in the 'Declaration', 'Authority' and 'Eligibility' sections (refer to section 3 <i>Signatory</i>)	1. Must be 'true' or '1'

6.3.4. bnRenewal Reply Message

Business Document Header

The WIG provides the standard specification of the Business Document Header. The following table specifies the message level specific data element values or any variations to the WIG.

Element Name	Instructions / Rules
MessageType	1. Mandatory, value is "bnRenewal"
asicReferenceNumber	1. Mandatory – transaction unique identifier assigned by ASIC for this transaction

Business Document Body

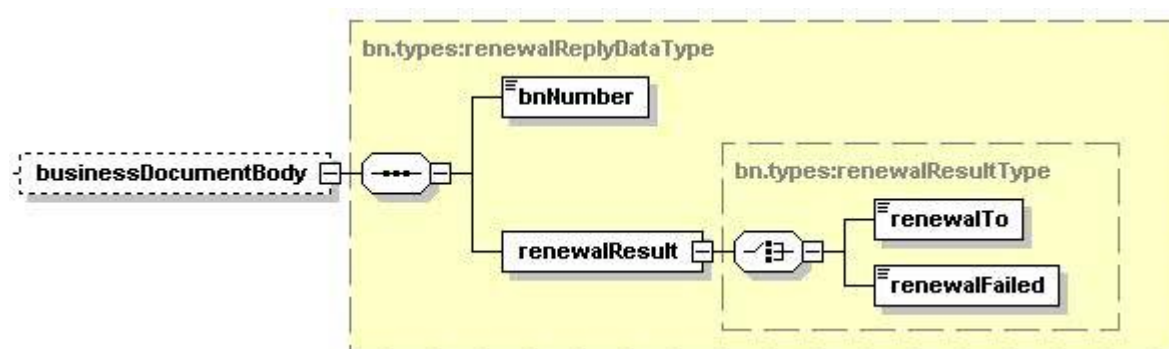

Message Content Table

Seq. No	XML Element	Type	Description
1	bnNumber	types:nniNumber type	Internal number for the business name.
2	renewalTo	xs:date	The proposed renewal date once the renewal fee is paid and renewal is complete.
3.	renewalFailed	Types:trueType	Indicates that the renewal has failed.

APPENDIX A – Mapping ABR entity types to ASIC entity types

ASIC business entity	ABR entity type
Incorporated body	PRV – Australian Private Company PUB – Australian Public Company CCR - Australian Private Company – Commonwealth LCR - Australian Private Company – Local SCR - Australian Private Company – State TCR - Australian Private Company – Territory CCB - Australian Public Company – Commonwealth LCB - Australian Public Company – Local SCB - Australian Public Company – State TCB - Australian Public Company – Territory PDF - Pooled Development Fund CCP - Pooled Development Fund – Commonwealth LCP - Pooled Development Fund – Local SCP - Pooled Development Fund – State TCP - Pooled Development Fund - Territory
Individual	IND - Individual
Partnership	FPT – Family Partnership LPT – Limited Partnership PTR – Other Partnership LCL - Limited Partnership – Local SCL - Limited Partnership – State TCL - Limited Partnership – Territory CGP - Other Partnership – Commonwealth LGP - Other Partnership – Local SGP - Other Partnership – State TGP - Other Partnership - Territory
Unincorporated entity	All other types such as: ADF – Approved Deposit Fund ARF – APRA Regulated Fund (Fund Type Unknown) CCC - Co-operative – Commonwealth CCN - Other Unincorporated Entity – Commonwealth CCU - Corporate Unit Trust – Commonwealth CGA - Commonwealth Government Statutory Authority CGC - Commonwealth Government Company CGE - Commonwealth Government Entity CGS - Commonwealth Government Superannuation Fund CGT - Commonwealth Government Trust CMT – Cash Management Trust COP – Co-operative CSA - APRA-Regulated Super Fund -Commonwealth - Public Sector Fund CSP - APRA-Regulated Super Fund - Commonwealth - Public Sector Scheme CSS - A Non-Regulated Superannuation Fund – Commonwealth

ASIC business entity	ABR entity type
	CTC - Cash Management Trust – Commonwealth CTD - Discretionary Trust - Services Management – Commonwealth CTF - Fixed Trust – Commonwealth CTH - Hybrid Trust – Commonwealth CTI - Discretionary Trust - Investment – Commonwealth CTL - Public Unit Trust - Listed – Commonwealth CTQ - Public Unit Trust - Unlisted – Commonwealth CTT - Discretionary Trust - Trading – Commonwealth CTU - Fixed Unit Trust - Commonwealth CUT – Corporate Unit Trust DES – Deceased Estate DIP – Diplomatic Consulate Body or High Commissioner DIT – Discretionary Investment Trust DST – Discretionary Service Management Trust DTT – Discretionary Trading Trust FHS – First Home Saver Account (FHSA) Trust FUT – Fixed Unit Trust FXT – Fixed Trust HYT – Hybrid Trust LCC - Co-operative – Local LCN – Other Unincorporated Entity - Local LCU - Corporate Unit Trust – Local LGA - Local Government Statutory Authority LGC - Local Government Company LGE - Local Government Entity LGT - Local Government Trust LSA - APRA-Regulated Super Fund - Local - Public Sector Fund LSP - APRA-Regulated Super Fund - Local - Public Sector Scheme LSS - A Non-Regulated Superannuation Fund – Local LTC - Cash Management Trust – Local LTD - Discretionary Trust - Services Management – Local LTF - Fixed Trust – Local LTH - Hybrid Trust – Local LTI - Discretionary Trust - Investment – Local LTL - Public Unit Trust - Listed – Local LTQ - Public Unit Trust - Unlisted – Local LTT - Discretionary Trust - Trading – Local LTU - Fixed Unit Trust - Local NPF – APRA Regulated Non-Public Offer Fund NRF – Non-Regulated Superannuation Fund POF – APRA Regulated Public Offer Fund PQT – Unlisted Public Unit Trust PST – Pooled Superannuation Trust PUT – Listed Public Unit Trust SAF – Small APRA Regulated Fund

ASIC business entity	ABR entity type
	SCC - Co-operative – State SCN - Other Unincorporated Entity – State SCU - Corporate Unit Trust – State SGA - State Government Statutory Authority SGC - State Government Company SGE - State Government Entity SGT - State Government Trust SMF – An ATO Regulated Self-Managed Superannuation Fund SSA - APRA-Regulated Super Fund - State - Public Sector Fund SSP - APRA-Regulated Super Fund - State - Public Sector Scheme SSS - A Non-Regulated Superannuation Fund – State STC - Cash Management Trust – State STD - Discretionary Trust - Services Management – State STF - Fixed Trust – State STH - Hybrid Trust – State STI - Discretionary Trust - Investment – State STL - Public Unit Trust - Listed – State STQ - Public Unit Trust - Unlisted – State STT - Discretionary Trust - Trading – State STU - Fixed Unit Trust – State SUP - Super Fund TCC - Co-operative – Territory TCN - Other Unincorporated Entity – Territory TCU - Corporate Unit Trust – Territory TGA - Territory Government Statutory Authority TGE - Territory Government Entity TGT - Territory Government Trust TRT - Other Trust TSA - APRA-Regulated Super Fund - Territory - Public Sector Fund TSP - APRA-Regulated Super Fund - Territory - Public Sector Scheme TSS - A Non-Regulated Superannuation Fund – Territory TTC - Cash Management Trust – Territory TTD - Discretionary Trust - Services Management – Territory TTF - Fixed Trust – Territory TTH - Hybrid Trust – Territory TTI - Discretionary Trust - Investment – Territory TTL - Public Unit Trust - Listed – Territory TTQ – Public Unit Trust - Unlisted – Territory TTT - Discretionary Trust - Trading – Territory TTU - Fixed Unit Trust - Territory UIE - Other Unincorporated Entity
Incorporated body/ Unincorporated entity The entities in this category may in some	OIE – Other Incorporated Entity CCO - Other Incorporated Entity – Commonwealth LCO - Other Incorporated Entity – Local SCO - Other Incorporated Entity – State

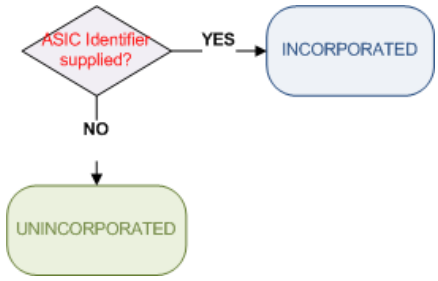
ASIC business entity	ABR entity type
<p>cases be registered with ASIC and therefore able to supply an ACN or ARBN.</p>  <pre> graph TD A{ASIC Identifier supplied?} -- YES --> B(INCORPORATED) A -- NO --> C(UNINCORPORATED) </pre> <p>If the entity supplies an ACN or ARBN we will treat them as 'Incorporated body'.</p> <p>If the entity can't provide an ACN/ARBN we will treat them as 'Unincorporated' entities.</p>	<p>TCO - Other Incorporated Entity – Territory CCS - Strata-title – Commonwealth CCT - Public Trading Trust – Commonwealth LCS - Strata-title – Local LCT - Public Trading Trust – Local PTT – Public Trading Trust SCS - Strata-title – State SCT - Public Trading Trust – State STR – Strata-title TCS - Strata-title – Territory TCT - Public Trading Trust – Territory</p>
<p>Joint-Venture</p>	<p>N/A Comment: Joint ventures that are not incorporated with ABR and do not have an ABN must supply the ABN for each participant</p>
<p>Christmas Island and Cocos Islands entities</p>	<p>N/A Comment: These must be businesses run entirely in those territories only and that are not eligible for an ABN.</p>

APPENDIX B - RENEWAL DATE ALIGNMENT

If the business holder owns another business name(s) or the holder is a company then the user is presented with options to align the renewal date of the in progress application with one of the renewal dates for the other business name(s) or with the company's review date.

As per the legislation, alignment to alternative dates is only allowed under certain conditions.

The alternative registration dates are presented only if they match the following rules:

a) 1 year registration - of no more than 18 months and no less than 3 months from application date

and

(b) 3 year registration - of no more than 3 years and 6 months and no less than 18 months from application date.

Example

Assume a company completes an online application to register a new business name @01/06/2012.

Application date = 01/06/2012

Company review date = 28/07/2012 (provided by ASIC in ASIC service)

Step 1: Calculate next three subsequent review dates (to cover up to 3 year renewal period) from review date provided:

28/07/12; 28/07/2013; 28/07/2014; 28/07/2015

Step 2: Calculate allowable date ranges for 1 and 3 year registration options:

One year registration date range :

Start date = 'Application date' + 3 months = 01/09/2012

End date = 'Application date'+18 months= 01/12/2013

Three year registration date range:

Start date = 'Application date' + 18 months + 1 day =02/12/2013

End date = 'Application date'+3 years + 6 months= 30/11/2015

Step 3: Determine if company review dates fall within permissible range for renewal alignment

FOR each review date calculated in Step 1

IF review date >= one_year_start_date_range AND review date <= one_year_end_date_range THEN

Display as option for alignment under 1 year registration period

ELSE

Do not display under 1 year registration period

IF review date >= three_year_start_date_range AND review date <= three_year_end_date_range THEN

Display as option for alignment under 3 year registration period

ELSE

Do not display under 3 year registration period

NEXT

Results of the above pseudo algorithm should yield:

28/07/2012 NO 1 year, NO 3 year

28/07/2013 YES 1 year, NO 3 year

28/07/2014 NO 1 year, YES 3 years

28/07/2015 NO 1 year, YES 3 years

APPENDIX C – List of Values

Organisation types	
Code	Description
APTY	Australian Proprietary Company
APUB	Australian Public Company
ASSN	Association
BUSN	Business Name
CHAR	Charity
COMP	Community Purpose
COOP	Co-Operative Society
LTDP	Limited Partnership
MISM	Managed Investment Scheme
NONC	Non Company
NRET	Non Registered Entity
RACN	Registered Australian Body
REBD	Religious Body
RSVN	Name Reservation
SOLS	Solicitor Corporation
TRST	Trust

Address types	
Code	Description
RG	Registered office (Company)
RP	Registered office (foreign company)
PA	Principal Place of Business Address (Company)
RO	Registered Office in place of incorporation (foreign company)
GC	Residential address (business names)
GD	Address for the place of business (business names)
GE	Address for the service of documents (business names)
GL	Contact Address (business names)

Status types (values depend on the entity type)	
Code	Description
PEND	Pending registration
REGD	Registered
DRGD	Deregistered
HELD	Held
SOFF	Strike-off
EXAD	Under External Administration and/or Controller Appointed
CNCL	Cancelled

NRGD	Not registered
DMNT	Dormant

Street types				
Code	Code	Code	Code	Code
Accs	Cres	Gdns	Pkwy	Spur
Ally	Cres E	Gld	Pl	Sq
Ambl	Cres N	Glen	Pl E	Sq E
App	Cres S	Gly	Pl N	Sq N
Arc	Cres W	Gr	Pl S	Sq S
Art	Crsg	Gr E	Pl W	Sq W
Ave	Crss	Gr N	Plza	St
Ave Cn	Crss W	Gr S	Pnt	St Cn
Ave E	Crst	Gra	Port	St E
Ave Ex	Cso	Grn	Prom	St Ex
Ave N	Ct	Gte	Qdrt	St N
Ave S	Ct E	Hill	Quad	St S
Ave W	Ct N	Hts	Qy	St W
Bch	Ct S	Hwy	Qy E	Stps
Bdwy	Ct W	Hwy E	Qy W	Strp
Bend	Ctr	Hwy N	Qys	Tarn
Brae	Cttg	Hwy S	Ramp	Tce
Brce	Ctyd	Hwy W	Rch	Tce E
Brk	Dale	Jnc	Rd	Tce Ex
Brow	Dell	Key	Rd Cn	Tce N
Bvd	Devn	Lane	Rd E	Tce S
Bvd E	Dr	Lane E	Rd Ex	Tce W
Bvd S	Dr E	Lane N	Rd Lr	Top
Bvd W	Dr N	Lane S	Rd N	Tor
Bypa	Dr S	Lane W	Rd S	Trk
Caus	Dr W	Line	Rd W	Trk E
Cct	Drwy	Link	Rdge	Trl
Cct E	Edge	Lkt	Rds	Turn
Cct W	Elb	Lnwy	Rdwy	Vale
Ch	End	Loop	Res	View
Cir	Ent	Mall	Rest	Vsta
Cir N	Esp	Mews	Ride	Walk
Cir S	Esp N	Mndr	Ring	Walk N
Cl	Esp S	Mwy	Rise	Walk S
Cl N	Est	Nook	Rmbl	Way
Cl S	Fawy	Otlk	Rnd	Way E
Clt	Fitr	Park	Rnge	Way N
Cmmn	Flat	Pass	Row	Way S
Cnr	Folw	Path	Rte	Way W
Con	Frnt	Pde	Rtt	Whrf
Cove	Frtg	Pde E	Run	Wkwy
Cps	Fshr	Pde N	Rvr	Wynd
Crcs	Ftrk	Pde S	SWy	
Crcs E	Fwy	Pde W	Sbwy	
Crcs W	Gap	Pkt	Slpe	

Postal delivery types	
Code	Description
CARE PO	Care of Post Office / Poste Restante
CMA	Community Mail Agent
CMB	Community Mail Bag
GPO BOX	General Post Office Box PostalDeliveryNumber is mandatory for this PostalDeliveryType
LOCKED BAG	Locked Mail Bag Service PostalDeliveryNumber is mandatory for this PostalDeliveryType
MS	Mail Service
PO BOX	Post Office Box PostalDeliveryNumber is mandatory for this PostalDeliveryType
PRIVATE BAG	Private Mail Bag Service PostalDeliveryNumber is mandatory for this PostalDeliveryType
RSD	Roadside Delivery
RMB	Roadside Mail Bag/Box PostalDeliveryNumber is mandatory for this PostalDeliveryType
RMS	Roadside Mail Service
CPA	Community Postal Agent

Country Descriptions		
Afghanistan	China	Guatemala
Aland Islands	Christmas Island	Guernsey
Albania	Cocos (Keeling) Islands	Guinea
Algeria	Colombia	Guinea-Bissau
American Samoa	Comoros	Guyana
Andorra	Congo	Haiti

Angola	Congo, Democratic Republic Of	Heard Is And Mcdonald Is
Anguilla	Cook Islands	Holy See (Vatican City State)
Antarctica	Costa Rica	Honduras
Antigua And Barbuda	Cote D'Ivoire	Hong Kong
Argentina	Croatia	Hungary
Armenia	Cuba	Iceland
Aruba	Curacao	India
Australia	Cyprus	Indonesia
Austria	Czech Republic	Iran, Islamic Republic Of
Azerbaijan	Denmark	Iraq
Bahamas	Djibouti	Ireland
Bahrain	Dominica	Isle Of Man
Bangladesh	Dominican Republic	Israel
Barbados	Ecuador	Italy
Belarus	Egypt	Jamaica
Belgium	El Salvador	Japan
Belize	Equatorial Guinea	Jersey
Benin	Eritrea	Jordan
Bermuda	Estonia	Kazakhstan
Bhutan	Ethiopia	Kenya
Bolivia	Falkland Islands (Malvinas)	Kiribati
Bonaire St Eustatius And Saba	Faroe Islands	Korea, DPR
Bosnia And Herzegovina	Fiji	Korea, Republic Of
Botswana	Finland	Kuwait
Bouvet Island	France	Kyrgyzstan
Brazil	French Guiana	Lao, PDR
British Indian Ocean Territory	French Polynesia	Latvia

Brunei Darussalam	French Southern Territories	Lebanon
Bulgaria	Gabon	Lesotho
Burkina Faso	Gambia	Liberia
Burundi	Georgia	Libyan Arab Jamahiriya
Cambodia	Germany	Liechtenstein
Cameroon	Ghana	Lithuania
Canada	Gibraltar	Luxembourg
Cape Verde	Greece	Macao
Cayman Islands	Greenland	Macedonia
Central African Republic	Grenada	Madagascar
Chad	Guadeloupe	Malawi
Chile	Guam	Malaysia
Maldives	Romania	Turkmenistan
Mali	Russian Federation	Turks And Caicos Islands
Malta	Rwanda	Tuvalu
Marshall Islands	Saint Barthelemy	Uganda
Martinique	St Helena Ascension Tris Cunha	Ukraine
Mauritania	Saint Kitts And Nevis	United Arab Emirates
Mauritius	Saint Lucia	United Kingdom
Mayotte	Saint Martin (French Part)	United States
Mexico	Saint Pierre And Miquelon	US Minor Outlying Islands
Micronesia	St Vincent And Grenadines	Uruguay
Moldova, Republic Of	Samoa	Uzbekistan
Monaco	San Marino	Vanuatu
Mongolia	Sao Tome And Principe	Venezuela, Bolivarian Republic
Montenegro	Saudi Arabia	Viet Nam
Montserrat	Senegal	Virgin Islands, British

Morocco	Serbia	Virgin Islands, U.S.
Mozambique	Seychelles	Wallis And Futuna
Myanmar	Sierra Leone	Western Sahara
Namibia	Singapore	Yemen
Nauru	Sint Maarten (Dutch Part)	Zambia
Nepal	Slovakia	Zimbabwe
Netherlands	Slovenia	Unknown
New Caledonia	Solomon Islands	Northern Ireland
New Zealand	Somalia	
Nicaragua	South Africa	
Niger	Sth Georgia Sth Sandwich Is	
Nigeria	Spain	
Niue	Sri Lanka	
Norfolk Island	Sudan	
Northern Mariana Islands	Suriname	
Norway	Svalbard And Jan Mayen	
Oman	Swaziland	
Pakistan	Sweden	
Palau	Switzerland	
Palestine, State Of	Syrian Arab Republic	
Panama	Taiwan	
Papua New Guinea	Tajikistan	
Paraguay	Tanzania, United Republic Of	
Peru	Thailand	
Philippines	Timor-Leste	
Pitcairn	Togo	
Poland	Tokelau	

Portugal	Tonga
Puerto Rico	Trinidad And Tobago
Qatar	Tunisia
Reunion	Turkey